

EDITION / VERSİYON
UPDATE / GÜNCELLEME

02/2018
07/2022

INTERIOR DOOR SYSTEM İÇ MEKAN KAPI SİSTEMİ

SYSTEM 24D SİSTEM 24D



KURTOĞLU®
ALUMINIUM





COMPANY INFORMATION

FİRMAMIZ HAKKINDA

Our company started its operations with copper and lead casting in the 1960s, and in 1980, we started to serve in the Aluminium Sector with aluminium extrusion press that has 1200 ton capacity. KURTOĞLU Aluminium is located in Corlu, approximately 100 km away from Istanbul and operates in 31.000 m2 indoor area. With our latest investments, our company has become a modern integrated facility.

- Annual production capacity ~ 34.000 tons,
- Approximately ~ 500 qualified employees,
- ISO 9001:2015 Quality System.
- Qualicoat Seaside Certificate,
- Qualanod Certificate,
- CE Certificate

The main production features of our Company are described as follows:

- Molding Room (Wire Erosion, Treatment Center),
- Aluminium Extrusion Presses, (800 tons, 1460 tons, 1880 tons, 1460/1880 tons, 2100 tons and 2600 tons),
- Anodic Oxidation Facility (75.000 amps - 412.500 m2 / month)
- Electrostatic Powder Paint Facility (750.000 m2 / month)
- Mechanical Processing Section (CNC Treatment Center)

Kurtoğlu Alüminyum exports its products to; U.S. America, New York, Los Angeles, San Francisco, Switzerland, Germany, Austria, Belgium, Sweden, Albania, England, Greece, Bulgaria, Cyprus, Serbia, Montenegro, Hungary, Georgia, Croatia, Turkmenistan, Kyrgyzstan, Azerbaijan, Moldova, Ukraine, Macedonia, Kosovo, Romania, Belarus, Czech Republic, Libya, Iraq, Algeria, Tunisia, Qatar, Nigeria, Israel, Ghana, Gabon, France, India, Saudi Arabia, Burkina Faso, Ethiopia, Egypt, Ivory Coast, Morocco, Poland, The Netherlands, Russia, Madagascar, Niger, Tanzania, Mozambique, Norway, Lebanon, Mayotte, Palestine, Senegal, Somali, Benin, Canada, Panama.

KURTOĞLU ALUMINIUM continues to operate based on the principle of providing services to its customers with zero fault.

Şirketimiz 1960' lı yıllarda Bakır ve Kurşun ile üretim hayatına başlamıştır. 1980 yılında 1200 tonluk Alüminyum Ekstrüzyon presi ile üretim sektörüne girmiştir.

KURTOĞLU Alüminyum; İstanbul'a yaklaşık 100 km mesafede Çorlu'da bulunmaktadır. 31.000 m² kapalı alanda faaliyetini sürdürmektedir. Son yapılan yatırımlarla şirketimiz modern bir entegre tesis haline ulaşmıştır.

- Yıllık kapasite ~ 34.000 ton,
- Yaklaşık ~ 500 kalifiye eleman,
- ISO 9001:2015 kalite sistemi,
- Qualicoat Seaside Belgesi,
- Qualanod Belgesi,
- CE Belgesi,

Şirketimizin ana özellikleri aşağıda da belirtilmiştir:

- Kalıphane Bölümü (Tel erozyon, İşleme Merkezi)
- Alüminyum Ekstrüzyon Presleri; (800 ton, 1460 ton, 1880 ton, 1460/1880 ton, 2100 ton ve 2600 ton),
- Elokso Tesisi (75.000 Amper - 412.500 m² / Ay)
- Elektrostatik Toz Boya Tesisi (750.000 m² / Ay)
- Mekanik İşlem Bölümü (CNC İşleme Merkezi)

KURTOĞLU Alüminyum Ürünleri; Amerika, New York, Los Angeles, San Francisco, İsviçre, Almanya, Avusturya, Belçika, İsveç, Arnavutluk, İngiltere , Yunanistan, Bulgaristan, Kıbrıs, Sırbistan, Karadağ, Macaristan, Gürcistan, Hırvatistan, Türkmenistan, Kırgızistan, Azerbaycan, Moldova, Ukrayna, Makedonya, Kosova, Romanya, Beyaz Rusya, Çek Cumhuriyeti, Libya, Irak, Cezayir, Tunus, Katar, Nijerya, İsrail, Gana, Gabon, Fransa, Hindistan, Suudi Arabistan, Burkina Faso, Etiyopya, Mısır, Fil Dişi Sahili, Fas, Polonya, Hollanda, Rusya Federasyonu, Madagaskar, Nijer, Tanzania, Mozambik, Norveç, Lübnan, Mayotte, Filistin, Senegal, Somali, Benin, Kanada, Panama' ya ihraç edilmektedir.

KURTOĞLU ALÜMİNYUM müşterilerine sıfır hata ile hizmet vermeyi temel alarak çalışmalarını sürdürmektedir.

'The countries of export; İhracat yapılan ülkeler'



Kurtoğlu Aluminium countries of export / İhracat yapılan ülkeler.

- U.S. America / Amerika
- New York
- Los Angeles
- San Francisco
- Switzerland / İsviçre
- Germany / Almanya
- Austria / Avusturya
- Belgium / Belçika
- Sweden / İsveç
- Albania / Arnavutluk
- England / İngiltere
- Greece / Yunanistan
- Bulgaria / Bulgaristan
- Cyprus / Kıbrıs
- Serbia / Sırbistan
- Montenegro / Karadağ
- Hungary / Macaristan
- Georgia / Gürcistan
- Croatia / Hırvatistan
- Turkmenistan / Türkmenistan
- Kyrgyzstan / Kırgızistan
- Azerbaijan / Azerbaycan
- Moldova / Moldova
- Ukraine / Ukrayna
- Macedonia / Makedonya
- Kosovo
- Romania / Romanya
- Belarus / Beyaz Rusya
- Czech Republic / Çek Cumhuriyeti
- Libya / Libya
- Iraq / Irak
- Algeria / Cezair
- Tunisia / Tunus
- Qatar / Katar
- Nigeria / Nijerya
- Israel / İsrail
- Ghana / Gana
- Gabon / Gabon
- France / Fransa
- India / Hindistan
- Saudi Arabia / Suudi Arabistan
- Burkina Faso / Burkina Faso
- Ethiopia / Etiyopya
- Egypt / Mısır
- Ivory Coast / Fil Dişi Sahili
- Morocco / Fas
- Poland / Polonya
- The Netherlands / Hollanda
- Russia / Rusya
- Madagascar / Madagaskar
- Niger / Nijer
- Tanzania / Tanzanya
- Mozambique / Mozambik
- Benin
- Palestine / Filistin
- Canada / Kanada
- Lebanon / Lübnan
- Mayotte / Mayotte
- Norway / Norveç
- Panama
- Senegal / Senegal
- Somali



KURTOĞLU[®]
ALUMINIUM





QUALITY POLICY

KALİTE POLİTİKASI

The company's quality policy is based upon the pillars of product quality, state of the art technology, customer satisfaction, training, environmental awareness, and continuous development. Kurtoğlu always implements this policy in all of its operations and units.

Şirketin kalite politikası ürün kalitesine, yeni teknolojilere, müşteri memnuniyetine, eğitime, çevre duyarlılığına ve sürekli gelişime dayanır. Kurtoğlu, her zaman tüm faaliyet ve birimlerinde bu politikayı uygular.

ORGADATA SOFTWARE & SOLUTION PARTNER

The conversational software Ksoft® matches perfectly with the requirements of all aluminum windows, door and curtain wall systems configuration, functionality and menu navigation. Ksoft® is a complete service package for architectural profile applications, and features all you need in the metal-processing operations with tremendous speed and perfection.

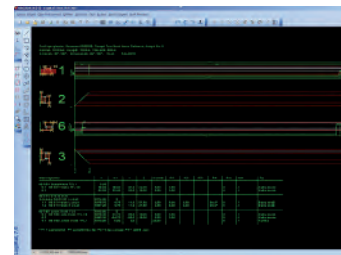
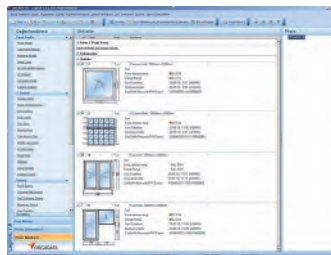
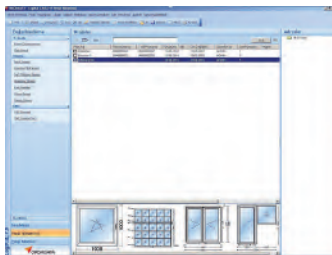
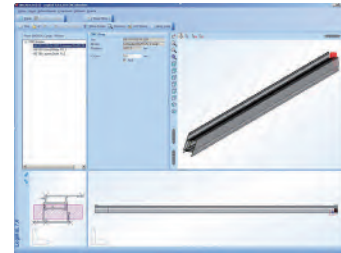
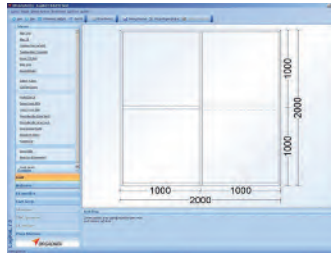
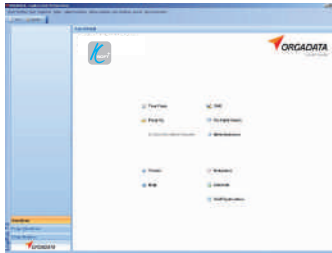

ORGADATA YAZILIM VE ÇÖZÜM ORTAĞI

İletişimli Ksoft® yazılımı tüm alüminyum pencereler, kapı ve cephe sistemleri konfigürasyon, fonksiyonel ve menü navigasyonu ile ilgili ihtiyaçları karşılar. Ksoft® yazılım programı mimari profil uygulaması ve metal işinde gerekli özellikleri optimum hız ve olağanüstü sunan tam bir program paketidir.

24D

APPLICATION TYPES / UYGULAMA TİPLERİ

EURO GROOVE FRAME
EURO KANAL KASA

24D-151-00

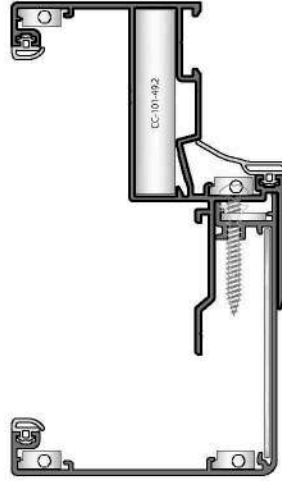

WOODEN DOOR SASH
AĞAÇ KAPI KANADI

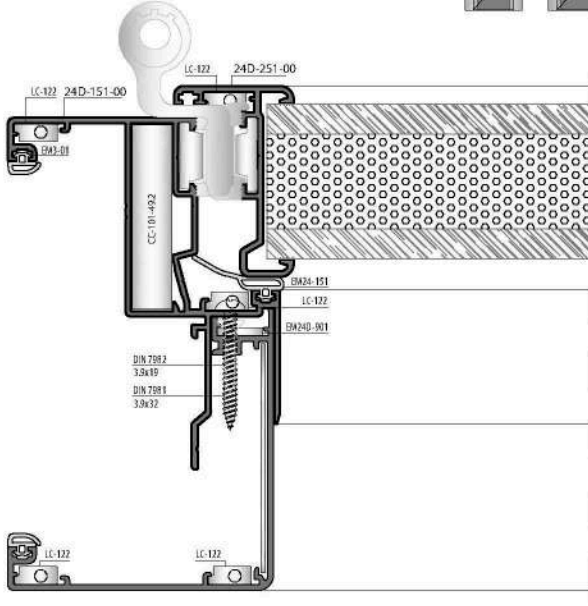
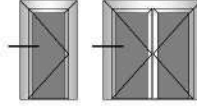

ALUMINIUM DOOR SASH
ALÜMİNYUM KAPI KANADI

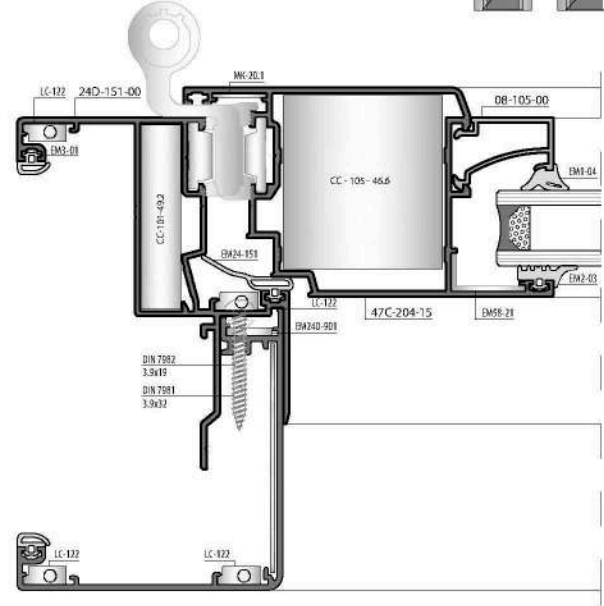
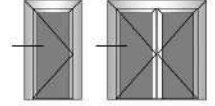

1:2 Scaled / 1:2 Ölçek

FLAT FRAME
DÜZ KASA

24D-152-00

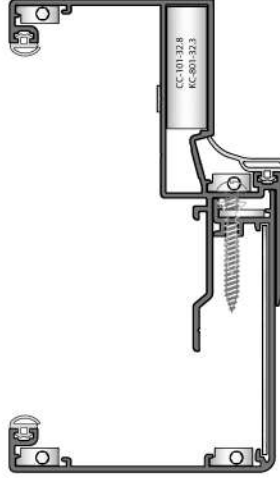

WOODEN DOOR
AHŞAP KAPI

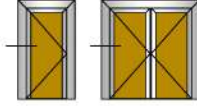

GLASS DOOR
CAM KAPI

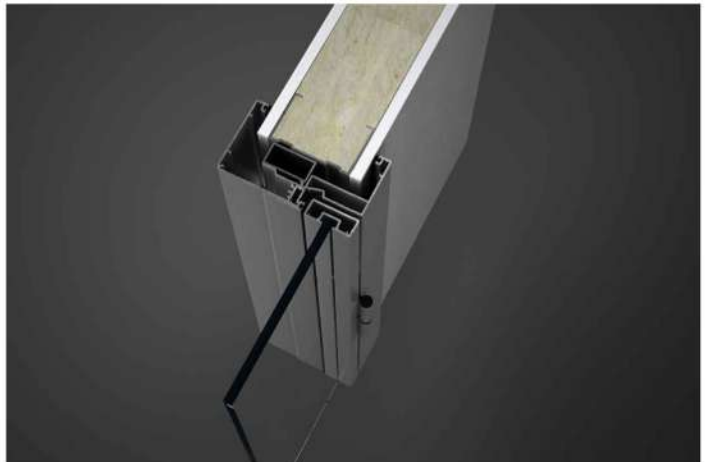
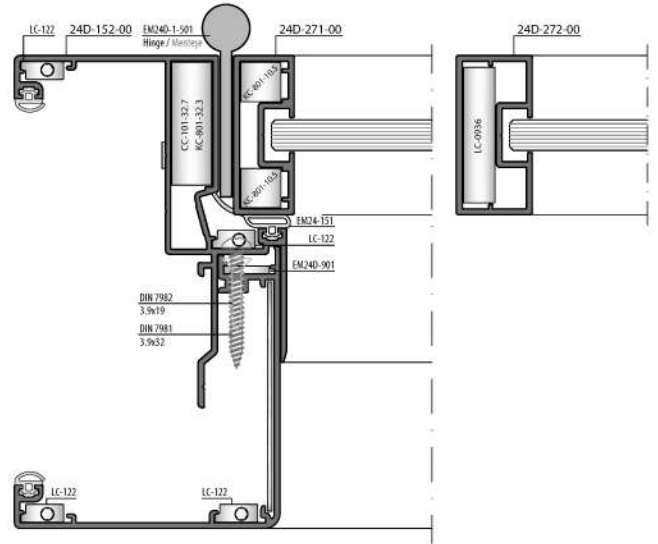
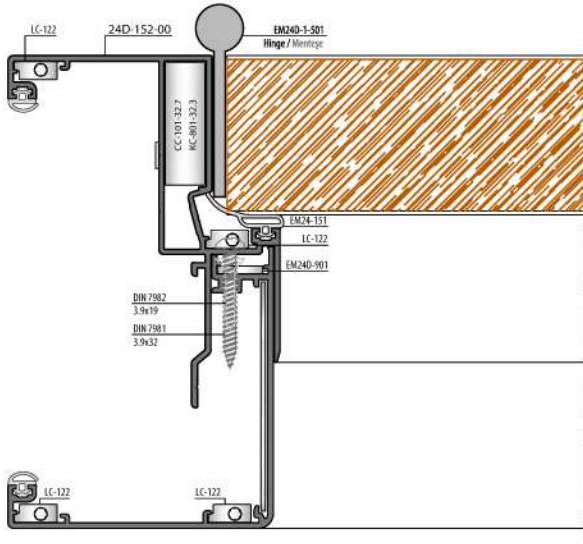
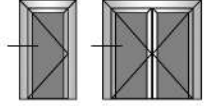

1:2 Scale / 1:2 Ölçek

FLAT FRAME
DÜZ KASA

24D-152-00

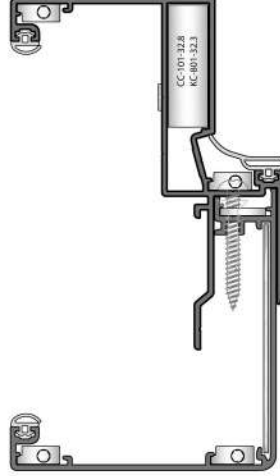

FLAT FRAME
DÜZ KASA

WOODEN DOOR
AĞAÇ KAPI

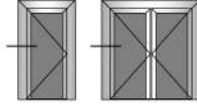

FLAT FRAME
DÜZ KASA

GLASS DOOR - 6 mm
CAM KAPI

GLASS DOOR - 8 mm
CAM KAPI

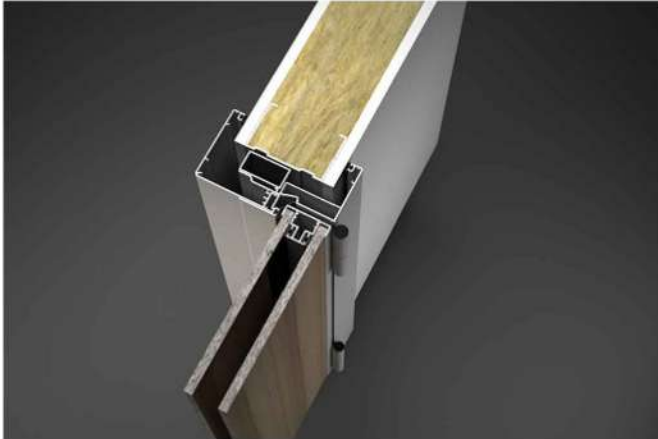
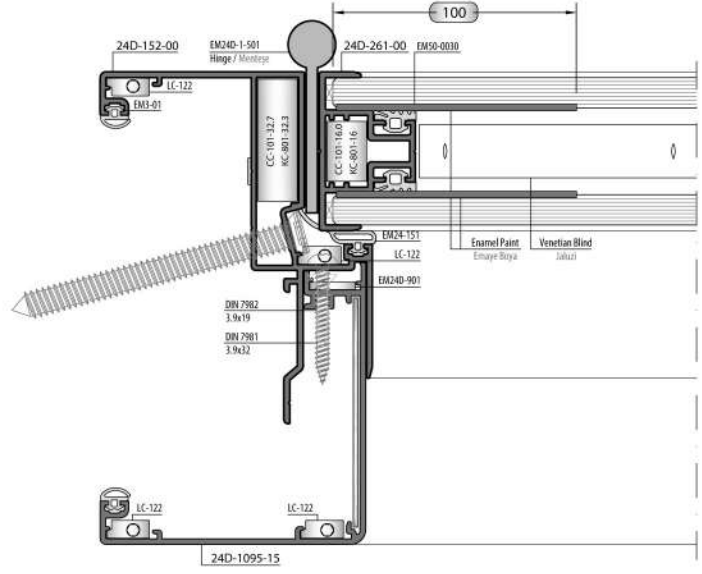
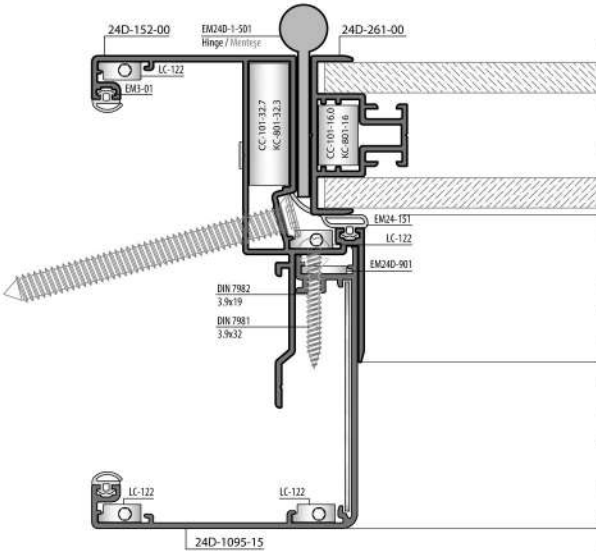
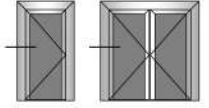

1:2 Scaled / 1:2 Ölçek

FLAT FRAME
DÜZ KASA

24D-152-00

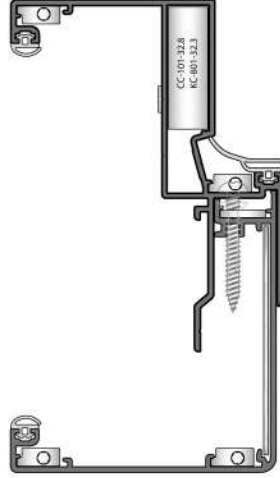

FLAT FRAME
DÜZ KASA

GLASS DOOR - 8 mm
CAM KAPI

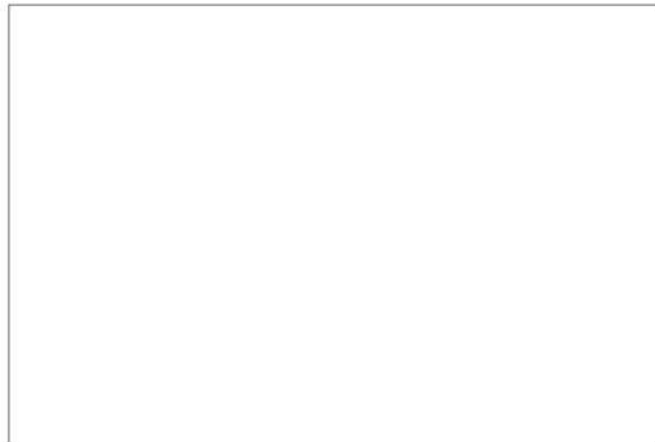
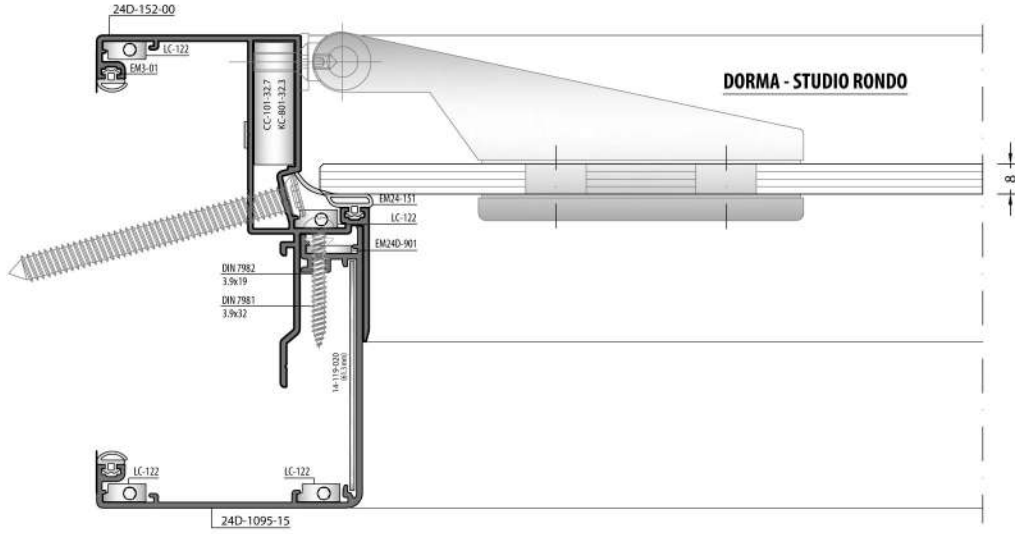
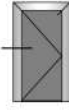

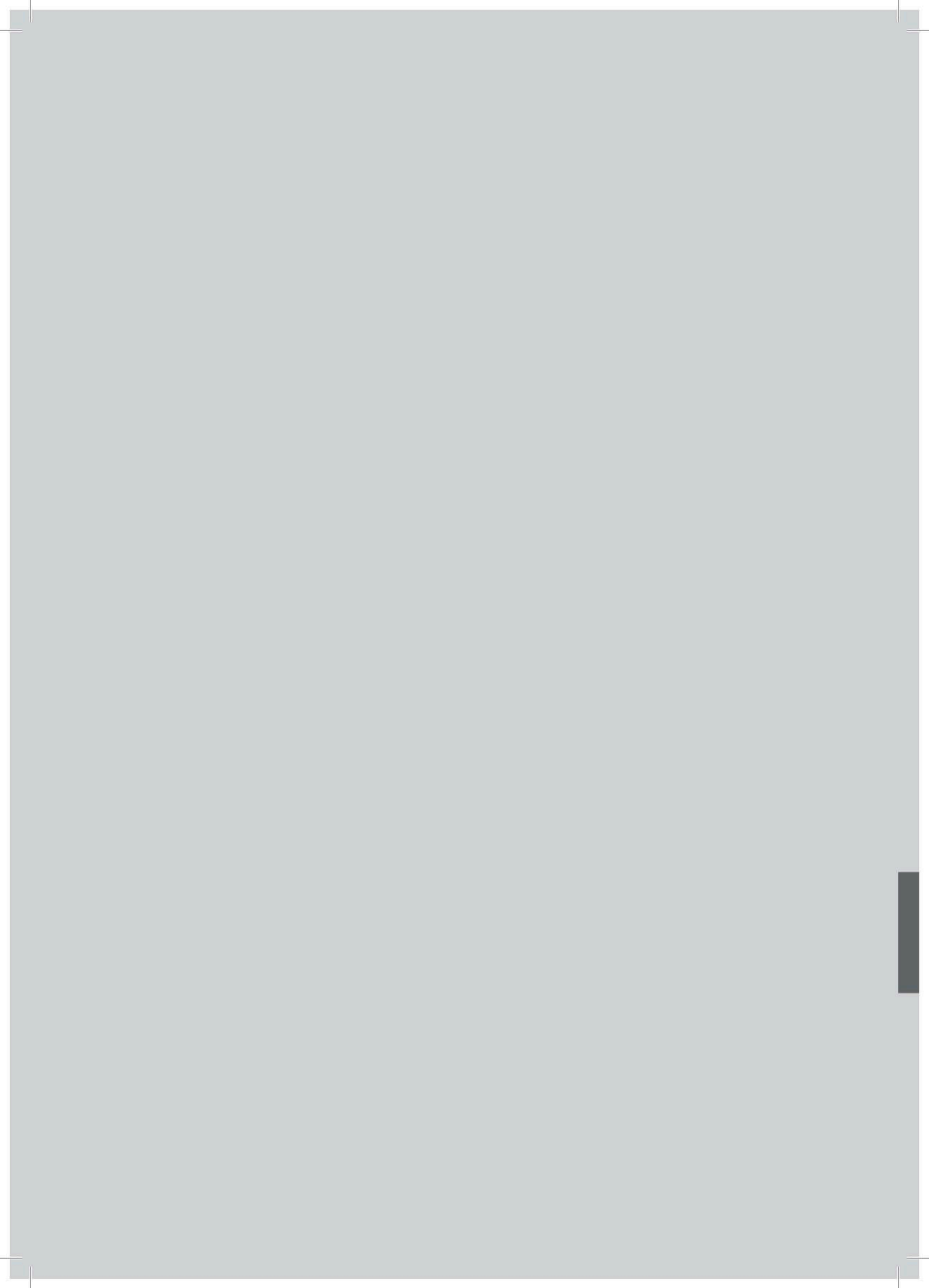

24D

PROFILES / PROFİLLER

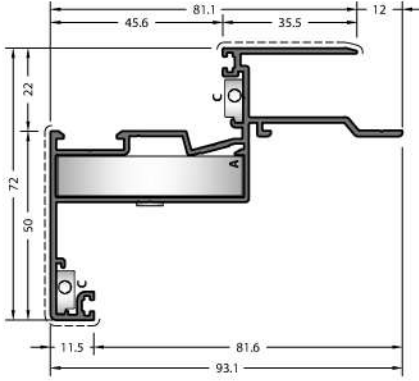

CODE / KOD
24D-151-00

THEORETICAL WEIGHT kg/m
TEORİK AĞIRLIK kg/m
1.223

- CORNER JOINTS**
KÖŞE BAĞLANTILAR
- A CC-101-49.2
 - C LC-122
- MECHANICAL CORNER JOINTS**
MEKANİK KÖŞE BAĞLANTILAR
- A KC-801-48.8

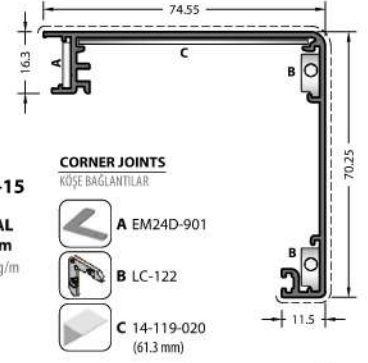

CODE / KOD
24D-1095-15

THEORETICAL WEIGHT kg/m
TEORİK AĞIRLIK kg/m
0.809

- CORNER JOINTS**
KÖŞE BAĞLANTILAR
- A EM24D-901
 - B LC-122
 - C 14-119-020 (61.3 mm)

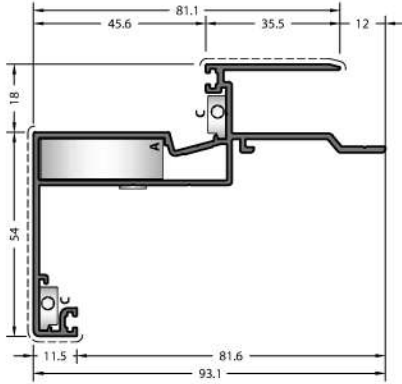

CODE / KOD
24D-152-00

THEORETICAL WEIGHT kg/m
TEORİK AĞIRLIK kg/m
1.175

- CORNER JOINTS**
KÖŞE BAĞLANTILAR
- A CC-101-32.7
 - B LC-122
- MECHANICAL CORNER JOINTS**
MEKANİK KÖŞE BAĞLANTILAR
- A KC-801-32.3

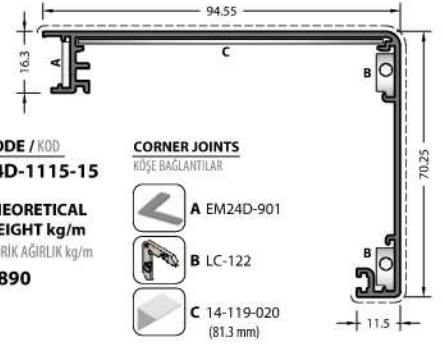

CODE / KOD
24D-1115-15

THEORETICAL WEIGHT kg/m
TEORİK AĞIRLIK kg/m
0.890

- CORNER JOINTS**
KÖŞE BAĞLANTILAR
- A EM24D-901
 - B LC-122
 - C 14-119-020 (81.3 mm)

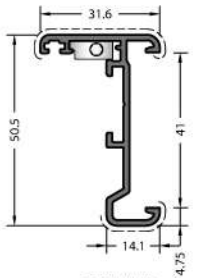

CODE / KOD
24D-251-00

THEORETICAL WEIGHT kg/m
TEORİK AĞIRLIK kg/m
0.522

- CORNER JOINTS**
KÖŞE BAĞLANTILAR
- C LC-122

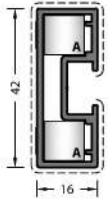

CODE / KOD
24D-271-00

THEORETICAL WEIGHT kg/m
TEORİK AĞIRLIK kg/m
0.552

- MECHANICAL CORNER JOINTS**
MEKANİK KÖŞE BAĞLANTILAR
- A KC-801-10.5

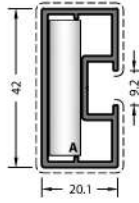

CODE / KOD
24D-272-00

THEORETICAL WEIGHT kg/m
TEORİK AĞIRLIK kg/m
0.574

- MECHANICAL CORNER JOINTS**
MEKANİK KÖŞE BAĞLANTILAR
- A LC-0936

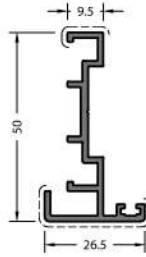

CODE / KOD
24D-571-00

THEORETICAL WEIGHT kg/m
TEORİK AĞIRLIK kg/m
0.509

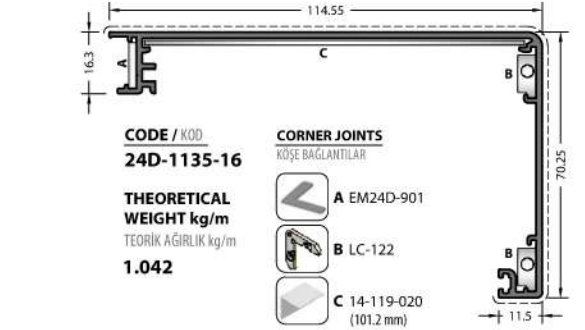

CODE / KOD
24D-1135-16

THEORETICAL WEIGHT kg/m
TEORİK AĞIRLIK kg/m
1.042

- CORNER JOINTS**
KÖŞE BAĞLANTILAR
- A EM24D-901
 - B LC-122
 - C 14-119-020 (101.2 mm)

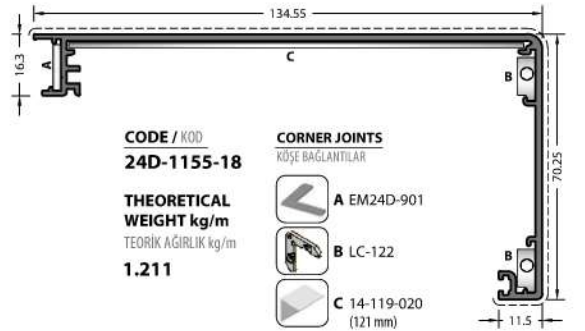

CODE / KOD
24D-1155-18

THEORETICAL WEIGHT kg/m
TEORİK AĞIRLIK kg/m
1.211

- CORNER JOINTS**
KÖŞE BAĞLANTILAR
- A EM24D-901
 - B LC-122
 - C 14-119-020 (121 mm)

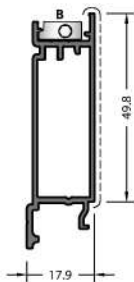

CODE / KOD
24D-1050-12

THEORETICAL WEIGHT kg/m
TEORİK AĞIRLIK kg/m
0.555

- CORNER JOINTS**
KÖŞE BAĞLANTILAR
- B LC-122

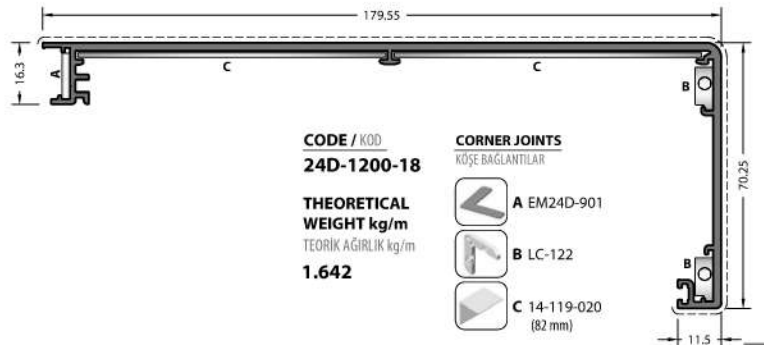

CODE / KOD
24D-1200-18

THEORETICAL WEIGHT kg/m
TEORİK AĞIRLIK kg/m
1.642

- CORNER JOINTS**
KÖŞE BAĞLANTILAR
- A EM24D-901
 - B LC-122
 - C 14-119-020 (82 mm)

1:2 Scale / 1:2 Ölçek

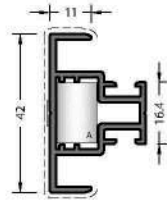

CODE / KOD
24D-261-00

THEORETICAL WEIGHT kg/m
TEORİK AĞIRLIK kg/m
0.594

CORNER JOINT
KOŞE BAĞLANTI

A CC-101-16.0

MECHANICAL CORNER JOINTS
MEKANİK KOŞE BAĞLANTILAR

A KC-801-16.0

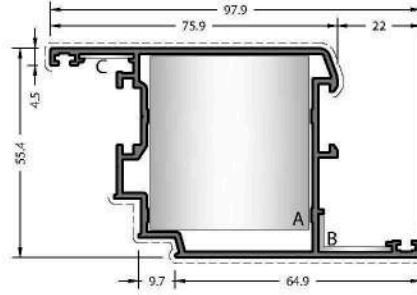

CODE / KOD
47C-204-15

THEORETICAL WEIGHT kg/m
TEORİK AĞIRLIK kg/m
1.261

CORNER JOINTS
KOŞE BAĞLANTILAR

A CC-105-46.6

B EM58-21

C MK-20.1

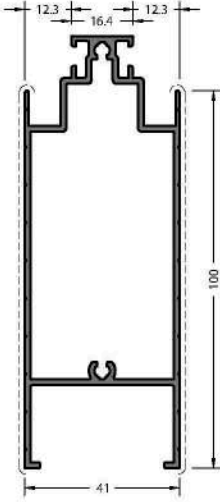

CODE / KOD
24D-262-00

THEORETICAL WEIGHT kg/m
TEORİK AĞIRLIK kg/m
1.410

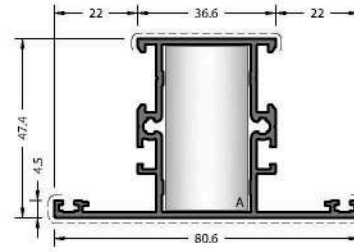

CODE / KOD
47C-302-15

THEORETICAL WEIGHT kg/m
TEORİK AĞIRLIK kg/m
1.110

CORNER JOINTS
KOŞE BAĞLANTILAR

A CC-905-22.5

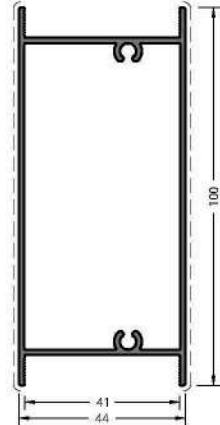

CODE / KOD
24D-452-00

THEORETICAL WEIGHT kg/m
TEORİK AĞIRLIK kg/m
1.156

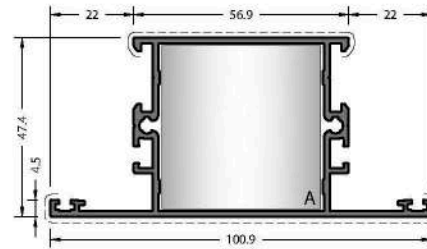

CODE / KOD
47C-304-15

THEORETICAL WEIGHT kg/m
TEORİK AĞIRLIK kg/m
1.275

CORNER JOINTS
KOŞE BAĞLANTILAR

A CC-905-42.8

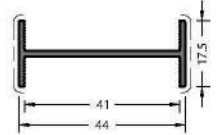

CODE / KOD
24D-451-00

THEORETICAL WEIGHT kg/m
TEORİK AĞIRLIK kg/m
0.299

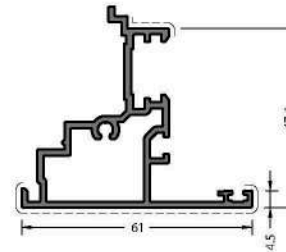

CODE / KOD
47C-501-00

THEORETICAL WEIGHT kg/m
TEORİK AĞIRLIK kg/m
0.967

CORNER JOINTS
KOŞE BAĞLANTILAR

A EM47C-501

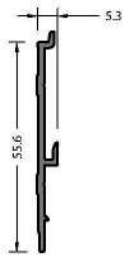

Mill Finish / Pres
No visible surface. / Gözlemlenir yüzeyi yoktur.

CODE / KOD
20-159-00

THEORETICAL WEIGHT kg/m
TEORİK AĞIRLIK kg/m
0.297

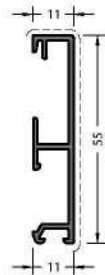

CODE / KOD
20-160-00

THEORETICAL WEIGHT kg/m
TEORİK AĞIRLIK kg/m
0.383

Application Details
Uygulama Detayı

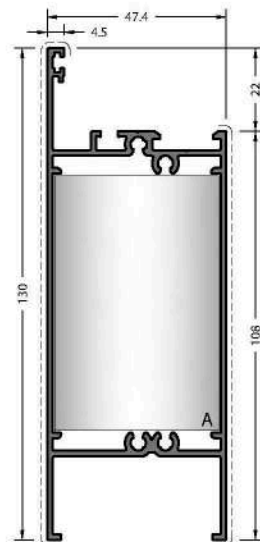
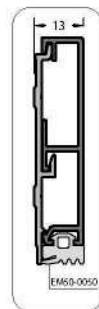

CODE / KOD
47C-401-15

THEORETICAL WEIGHT kg/m
TEORİK AĞIRLIK kg/m
1.633

CORNER JOINTS
KOŞE BAĞLANTILAR

A CC-905-68.1

1:2 Scaled / 1:2 Ölçek



CODE / KOD
08-101-00

THEORETICAL
WEIGHT kg/m
TEORİK AĞIRLIK kg/m
0.218



CODE / KOD
08-102-00

THEORETICAL
WEIGHT kg/m
TEORİK AĞIRLIK kg/m
0.224



CODE / KOD
08-103-00

THEORETICAL
WEIGHT kg/m
TEORİK AĞIRLIK kg/m
0.237



CODE / KOD
08-105-00

THEORETICAL
WEIGHT kg/m
TEORİK AĞIRLIK kg/m
0.260



CODE / KOD
08-107-00

THEORETICAL
WEIGHT kg/m
TEORİK AĞIRLIK kg/m
0.262



CODE / KOD
08-109-00

THEORETICAL
WEIGHT kg/m
TEORİK AĞIRLIK kg/m
0.280



CODE / KOD
08-110-00

THEORETICAL
WEIGHT kg/m
TEORİK AĞIRLIK kg/m
0.266



CODE / KOD
08-111-00

THEORETICAL
WEIGHT kg/m
TEORİK AĞIRLIK kg/m
0.216

ADAPTER CAP
ADAPTÖR KAPAĞI



EM08-111



CODE / KOD
08-112-00

THEORETICAL
WEIGHT kg/m
TEORİK AĞIRLIK kg/m
0.291

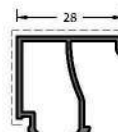

CODE / KOD
08-113-00

THEORETICAL
WEIGHT kg/m
TEORİK AĞIRLIK kg/m
0.300

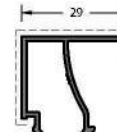

CODE / KOD
08-114-00

THEORETICAL
WEIGHT kg/m
TEORİK AĞIRLIK kg/m
0.306

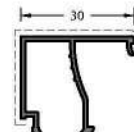

CODE / KOD
08-117-00

THEORETICAL
WEIGHT kg/m
TEORİK AĞIRLIK kg/m
0.309

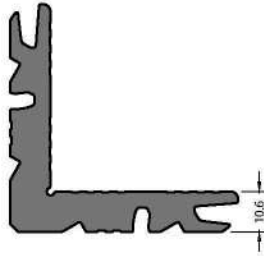

Mill Finish / Pres
No visible surface. / Görünen yüzeyi yoktur.

CODE / KOD
09-101-00

THEORETICAL
WEIGHT kg/m
TEORİK AĞIRLIK kg/m
2.561

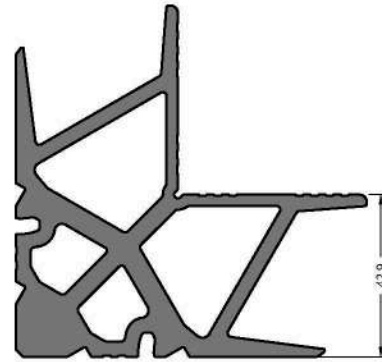

Mill Finish / Pres
No visible surface. / Görünen yüzeyi yoktur.

CODE / KOD
09-105-00

THEORETICAL
WEIGHT kg/m
TEORİK AĞIRLIK kg/m
5.453

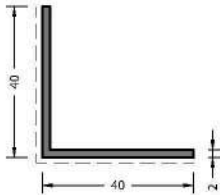

CODE / KOD
14-119-020

THEORETICAL
WEIGHT kg/m
TEORİK AĞIRLIK kg/m
0.421

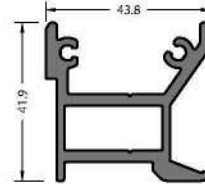

Mill Finish / Pres
No visible surface. / Görünen yüzeyi yoktur.

CODE / KOD
09-905-00

THEORETICAL
WEIGHT kg/m
TEORİK AĞIRLIK kg/m
1.288

GLAZING TABLE / CAM TABLOSU

GLAZING TABLE / CAM TABLOSU

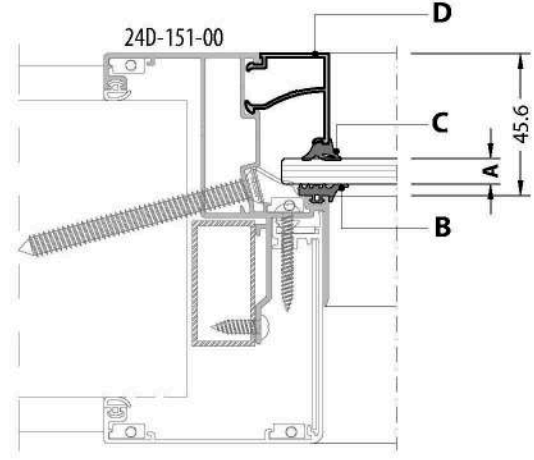
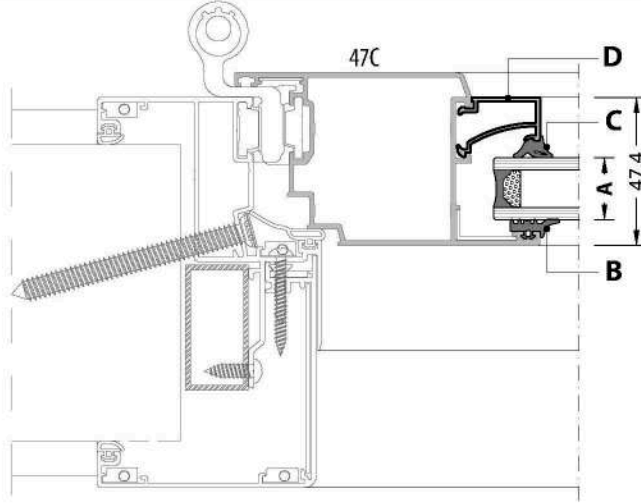

A	B	C	D
GLAZING THICKNESS CAM KALINLIĞI	OUTSIDE GLASS GASKET DIŞ CAM FİTİLİ	INSIDE GLASS GASKET İÇ CAM FİTİLİ	GLAZING BEAD CAM ÇITASI
4 mm	EM2-03	EM1-04	08-117-00
5 mm	EM2-03	EM1-03	08-117-00
		EM1-04	08-114-00
6 mm	EM2-03	EM1-02	08-117-00
		EM1-03	08-114-00
		EM1-04	08-113-00
8 mm	EM2-03	EM1-02	08-113-00
10 mm	EM2-03	EM1-03	08-112-00
12 mm	EM2-03	EM1-04	08-109-00
		EM1-04	08-110-00
		EM1-04	08-111-00
20 mm	EM2-03	EM1-04	08-105-00
22 mm	EM2-03	EM1-02	08-105-00
24 mm	EM2-03	EM1-04	08-103-00
26 mm	EM2-03	EM1-02	08-103-00
28 mm	EM2-03	EM1-03	08-102-00
30 mm	EM2-03	EM1-04	08-101-00
32 mm	EM2-03	EM1-02	08-101-00

A	B	C	D
GLAZING THICKNESS CAM KALINLIĞI	OUTSIDE GLASS GASKET DIŞ CAM FİTİLİ	INSIDE GLASS GASKET İÇ CAM FİTİLİ	GLAZING BEAD CAM ÇITASI
6 mm	EM2-03	EM1-05	08-117-00
8 mm	EM2-03	EM1-04	08-114-00
9 mm	EM2-03	EM1-03	08-114-00
10 mm	EM2-03	EM1-03	08-113-00
11 mm	EM2-03	EM1-05	08-112-00
12 mm	EM2-03	EM1-04	08-112-00
13 mm	EM2-03	EM1-03	08-112-00
20 mm	EM2-03	EM1-04	08-107-00
22 mm	EM2-03	EM1-05	08-105-00
24 mm	EM2-03	EM1-04	08-104-00
26 mm	EM2-03	EM1-05	08-103-00
28 mm	EM2-03	EM1-04	08-103-00
30 mm	EM2-03	EM1-04	08-102-00
32 mm	EM2-03	EM1-05	08-101-00
34 mm	EM2-03	EM1-03	08-101-00

24D

ACCESSORIES / AKSESUARLAR

CORNER CONNECTIONS / KÖŞE BAĞLANTILAR

CODE / KOD	DRAWING / ÇİZİM	APPLICATION UYGULAMA	PROFILE CODE PROFİL KOD	CUTTING SIZE KESİM ÖLÇÜSÜ	APPLICATION PROFILES ÇALIŞTIĞI PROFİLLER
CC-101-16.3			09-101-00	16.3 mm	24D-261-00
CC-101-32.8			09-101-00	32.8 mm	24D-152-00
CC-101-49.2			09-101-00	49.2 mm	24D-151-00
CC-105-46.6			09-105-00	46.6 mm	47C-204-15
KC-801-10.5			09-801-00	10.5 mm	24D-271-00
KC-801-16.0			09-801-00	16 mm	24D-261-00
KC-801-32.3			09-801-00	32.3 mm	24D-152-00
KC-801-48.8			09-801-00	48.8 mm	24D-151-00
EM58-21			-	-	47C-204-15
LC-122			-	-	24D-151-00 24D-152-00 24D-251-00 24D-1095-15 24D-1115-15 24D-1135-16 24D-1155-18 24D-1200-18 24D-1050-12
MK-20.1			-	-	47C-204-15
LC-0936			-	-	24D-272-00
EM24D-272			-	-	24D-272-00

CORNER CONNECTIONS / KÖŞE BAĞLANTILAR

CODE / KOD	DRAWING / ÇİZİM	APPLICATION UYGULAMA	PROFILE CODE PROFİL KOD	CUTTING SIZE KESİM ÖLÇÜSÜ	APPLICATION PROFILES ÇALIŞTIĞI PROFİLLER
EM24D-901			-	-	24D-1095-15 24D-1115-15 24D-1135-16 24D-1155-18 24D-1200-18
14-119-020			14-119-020	61.3 mm 81.3 mm 101.2 mm 121 mm 82 mm	24D-1095-15 24D-1115-15 24D-1135-16 24D-1155-18 24D-1200-18

OTHER ACCESSORIES / DİĞER AKSESUARLAR

PACKAGE CODE PAKET KODU	DRAWING / ÇİZİM	DESCRIPTION AÇIKLAMA	APPLICATION PROFILES ÇALIŞTIĞI PROFİLLER	CUTTING SIZE KESİM ÖLÇÜSÜ	MATERIAL MALZEME
EM47C-501		ADAPTER CAP ADAPTÖR KAPAĞI	47C-501-00	-	PVC

T JUNCTION / ÇEKTİRME BAĞLANTI

PACKAGE CODE PAKET KODU	DRAWING / ÇİZİM	DESCRIPTION AÇIKLAMA	APPLICATION PROFILES ÇALIŞTIĞI PROFİLLER	CUTTING SIZE KESİM ÖLÇÜSÜ	MATERIAL MALZEME
CC-905-22.5		T JUNCTION ÇEKTİRME BAĞLANTI	47C-302-15	22.5 mm	Alüminyum Alüminyum
CC-905-42.8		T JUNCTION ÇEKTİRME BAĞLANTI	47C-304-15	42.8 mm	Alüminyum Alüminyum
CC-905-68.1		T JUNCTION ÇEKTİRME BAĞLANTI	47C-401-15	68.1 mm	Alüminyum Alüminyum

ACCESSORIES / AKSESUARLAR

CODE / KOD	VIEW RESİM	DESCRIPTION AÇIKLAMA	QUANTITY MİKTAR
EM24D-1-101		HANDLE KOL	1 Pieces / Adet
EM24D-1-201		HANDLE COVER KOL AYNASI	1 Pieces / Adet
EM24D-1-301		HANDLE DİL	1 Pieces / Adet
EM24D-1-401		STRIKER KARŞILIK	1 Pieces / Adet
EM24D-1-501		HINGE MENTEŞE	1 Pieces / Adet
EM24D-1-601		DOOR LATCH KAPI SÜRGÜSÜ	1 Pieces / Adet

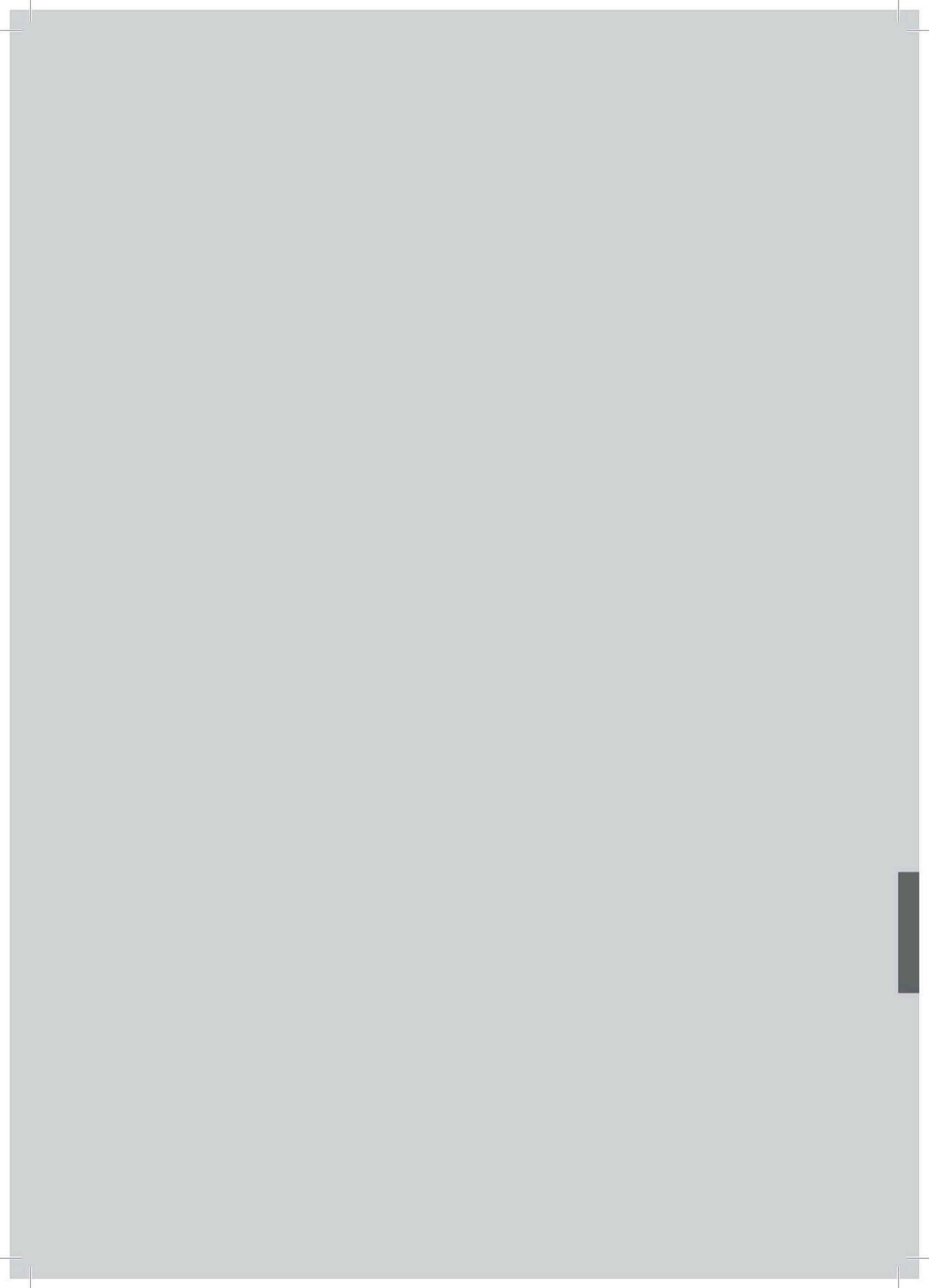

24D

DETAILS / DETAYLAR

EURO GROOVE FRAME
EURO KANAL KASA

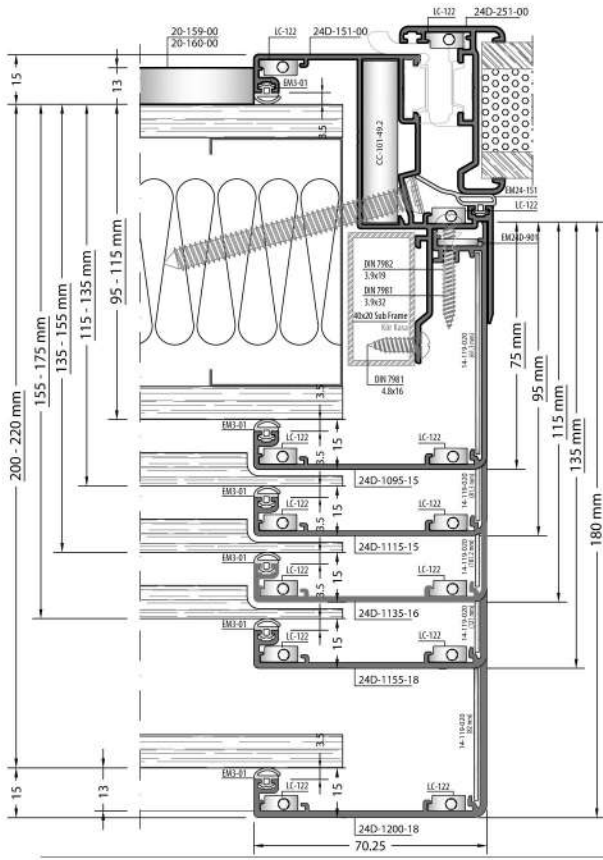

FLAT FRAME
DÜZ KASA

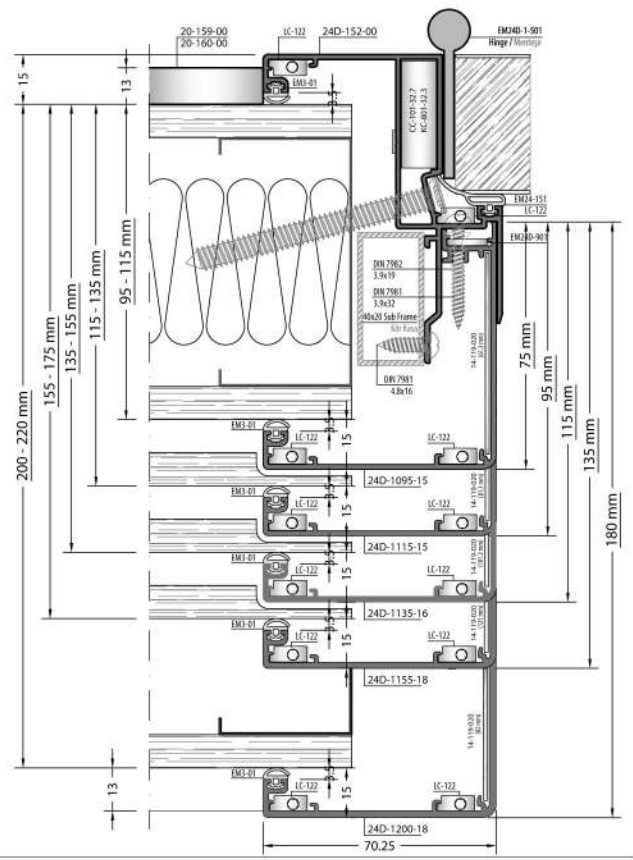

ADDITIONAL PROFILE
UZATMA PROFİLİ

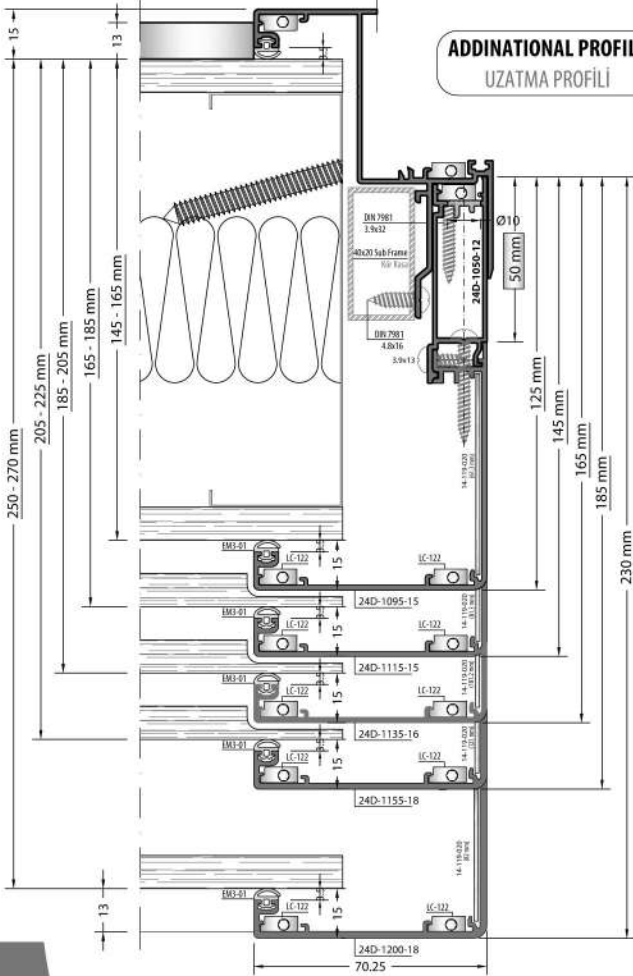

WALL THICKNESS / DUVAR KALINLIĞI

24D-1095-15	24D-1115-15	24D-1135-16	24D-1155-18	24D-1200-18
95 - 115 mm	115 - 135 mm	135 - 155 mm	155 - 175 mm	200 - 220 mm
145 - 165 mm	165 - 185 mm	185 - 205 mm	205 - 225 mm	250 - 270 mm

1:2 Scaled / 1:2 Ölçek

EURO GROOVE FRAME ALUMINIUM DOOR
EURO KANAL KASA ALÜMİNYUM KAPI

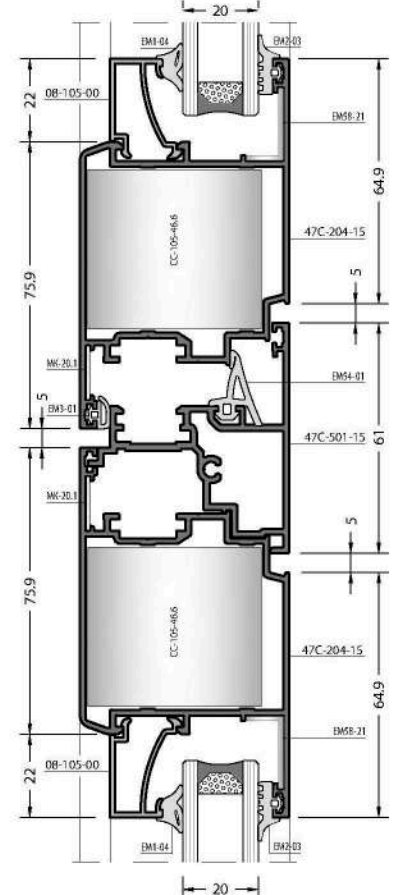
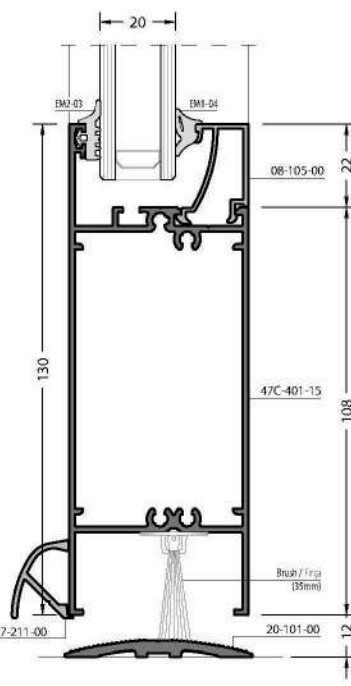
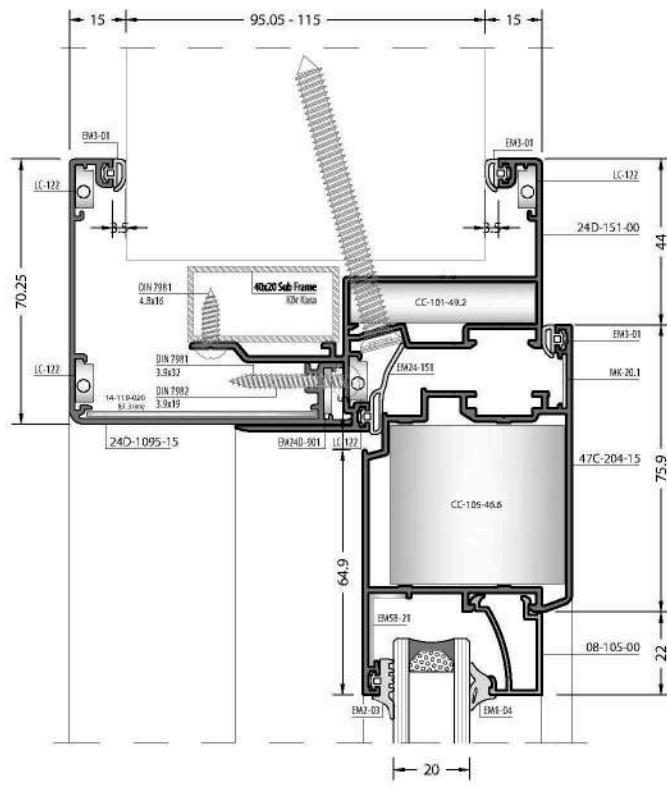
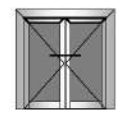
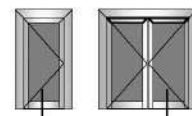
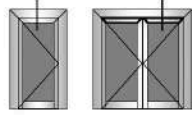
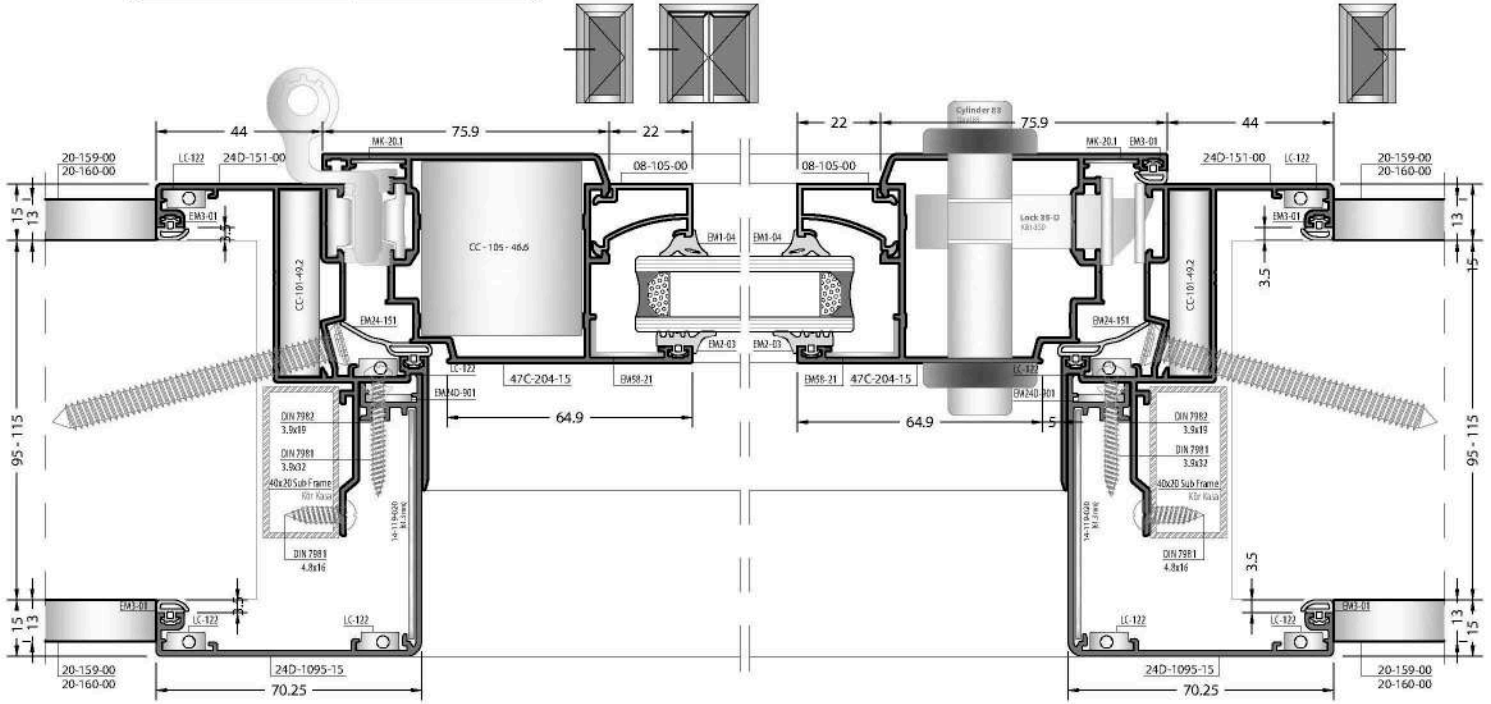

1:2 Scaled / 1:2 Ölçek

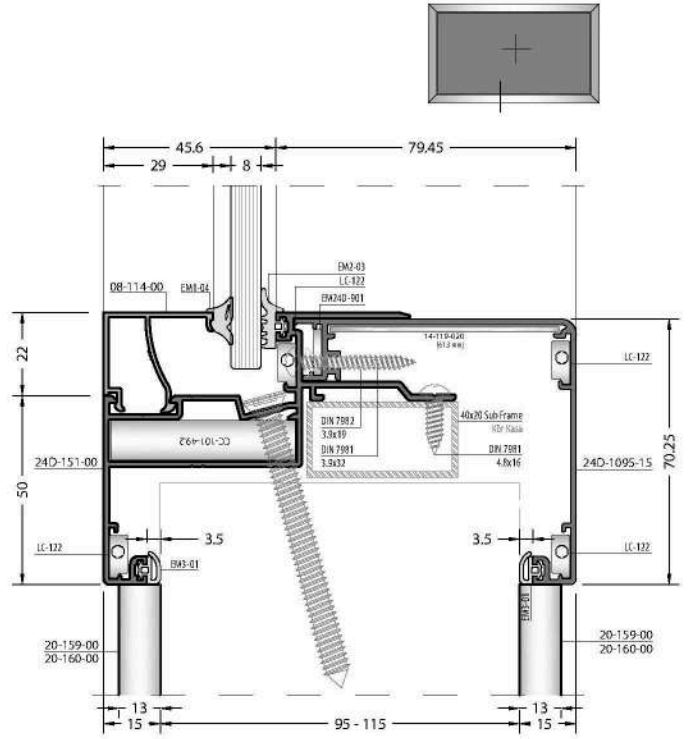
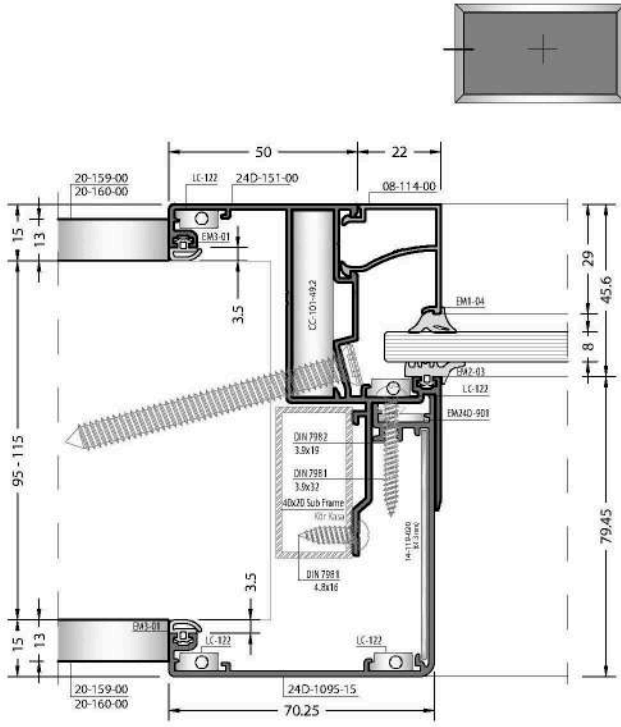

INTERIOR DOOR SYSTEM / İÇ MEKAN KAPI SİSTEMİ

FLAT FRAME
DÜZ KASA

WOODEN DOOR
AĞSAP KAPI

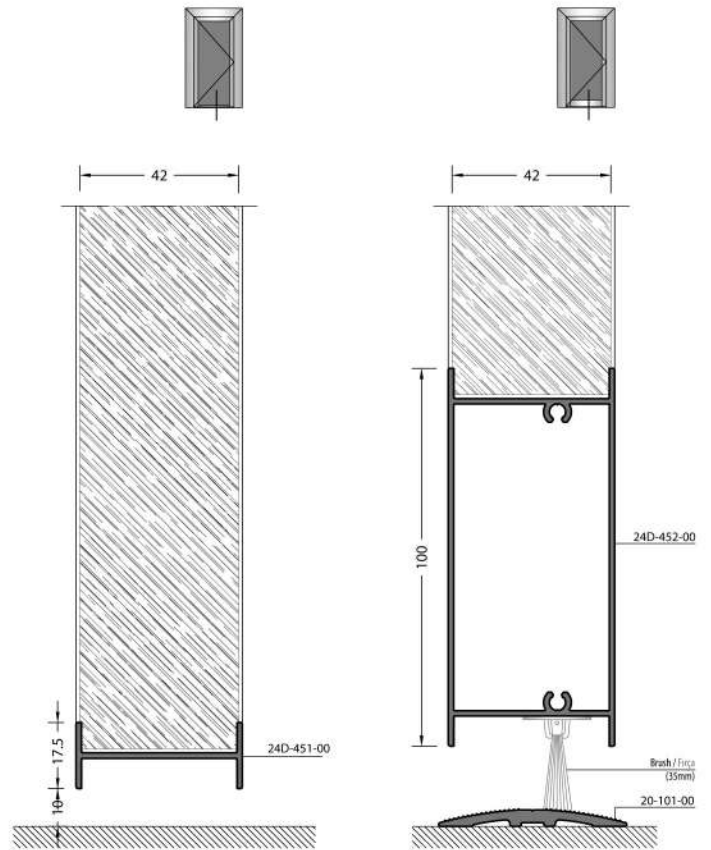
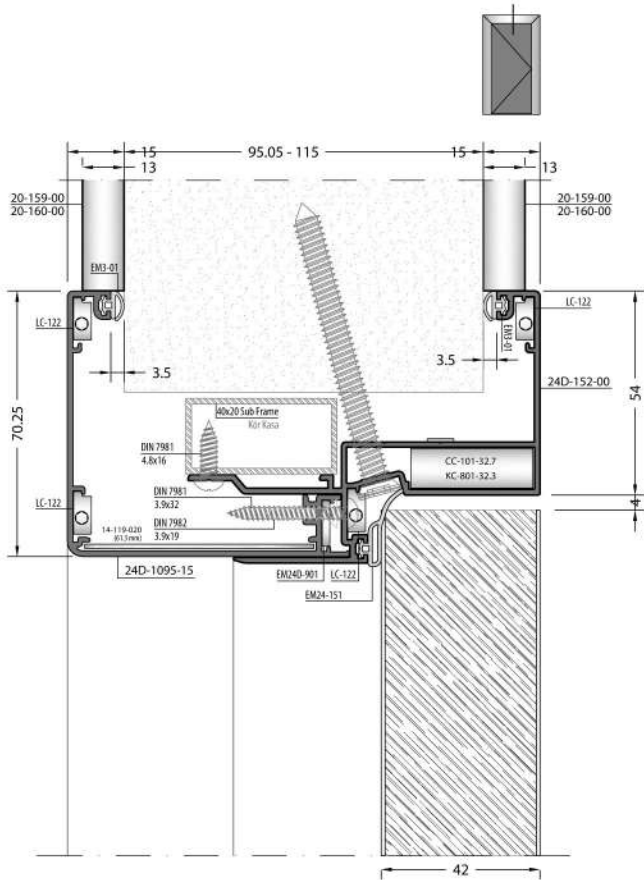
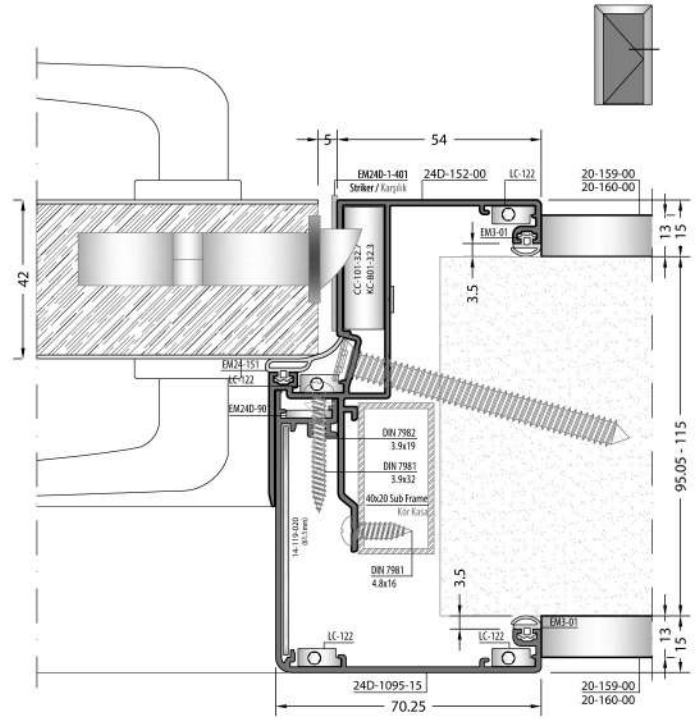
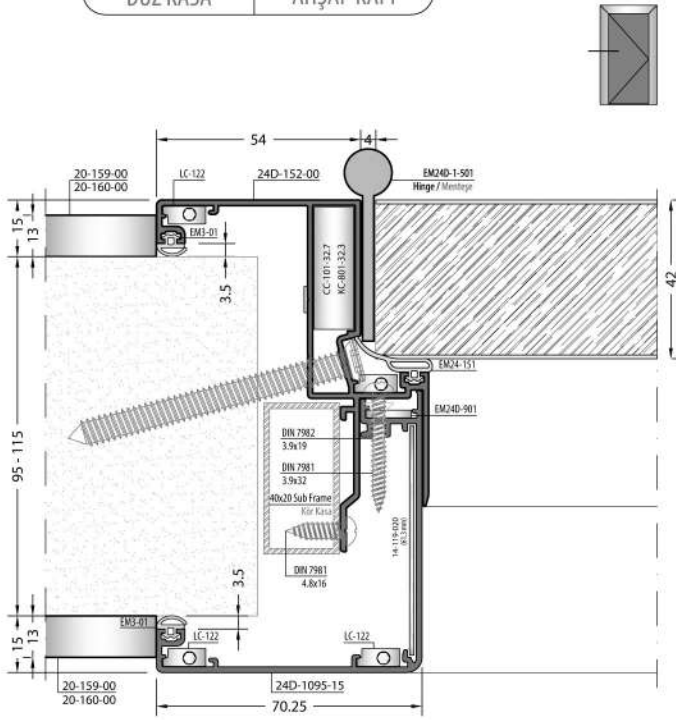

1:2 Scaled / 1:2 Ölçek

INTERIOR DOOR SYSTEM / İÇ MEKAN KAPI SİSTEMİ

FLAT FRAME
DÜZ KASA

GLASS DOOR
CAM KAPI

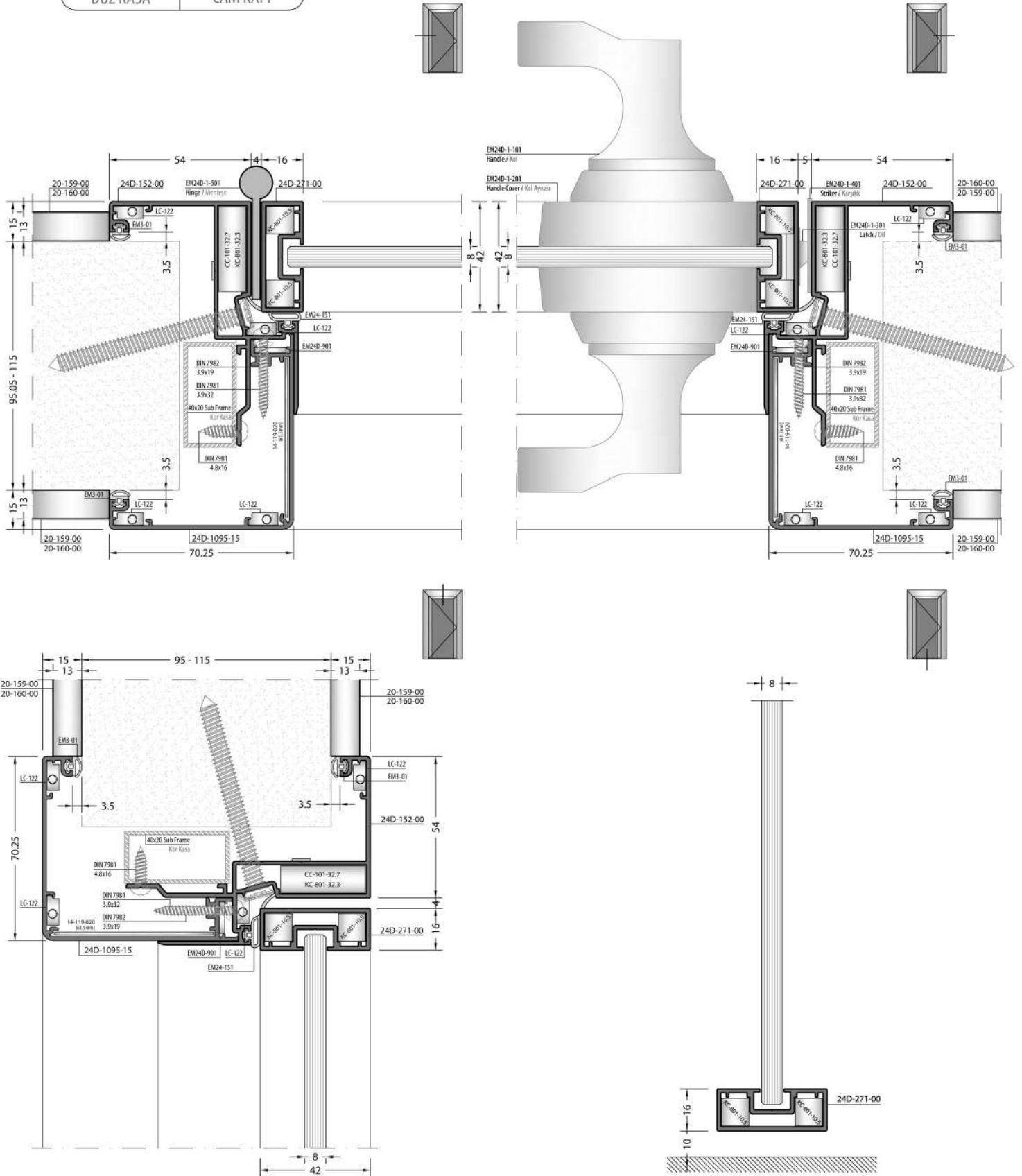

1:2 Scaled / 1:2 Ölçek

FLAT FRAME
DÜZ KASA

GLASS DOOR
CAM KAPI

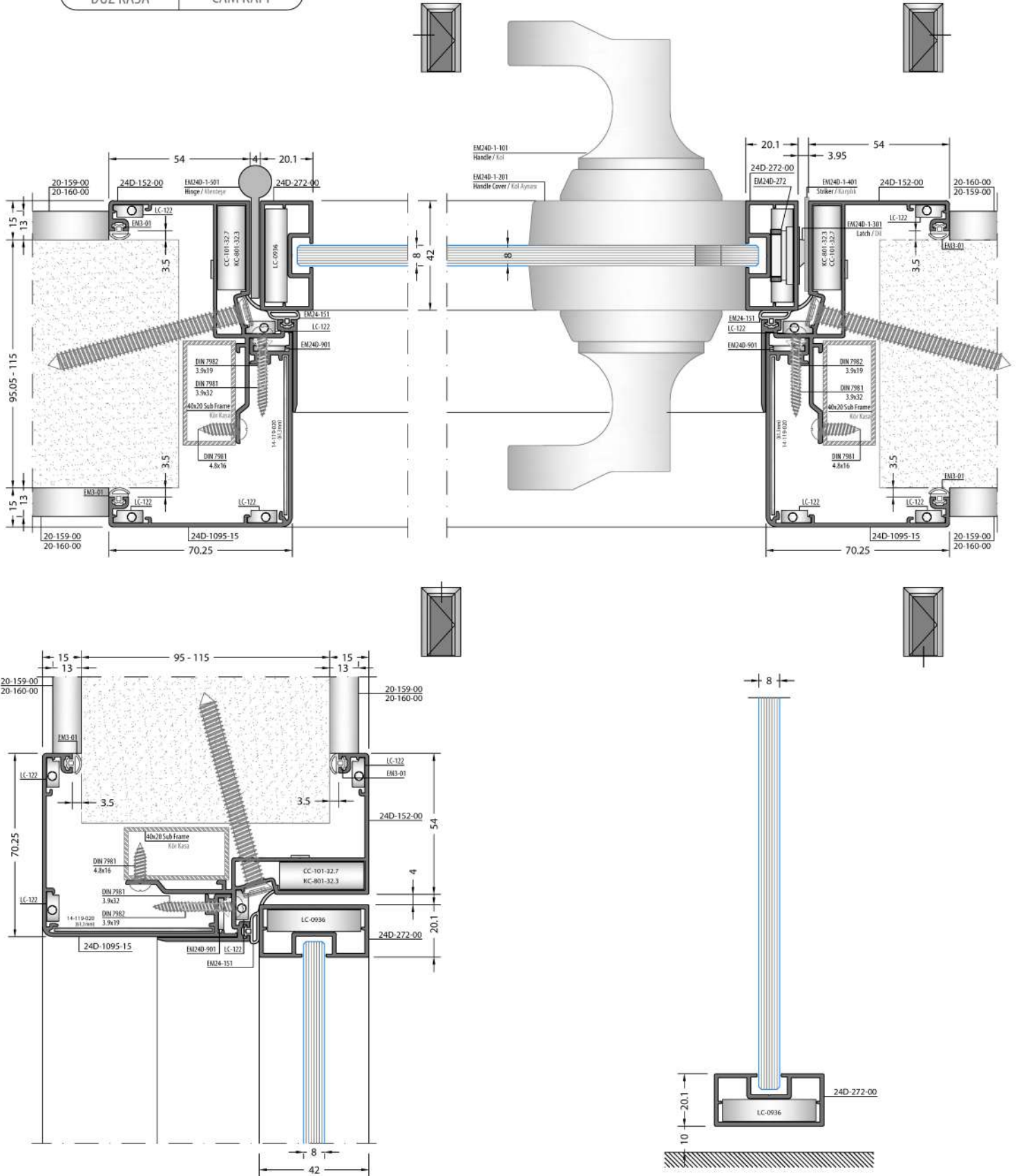

1:2 Scale / 1:2 Ölçek

INTERIOR DOOR SYSTEM / İÇ MEKAN KAPI SİSTEMİ

FLAT FRAME
DÜZ KASA

WOODEN DOOR
AHŞAP KAPI

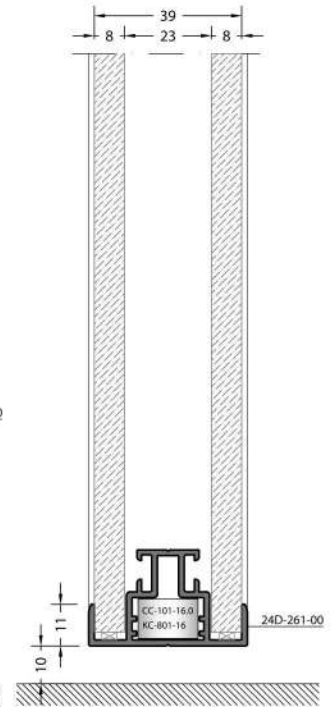
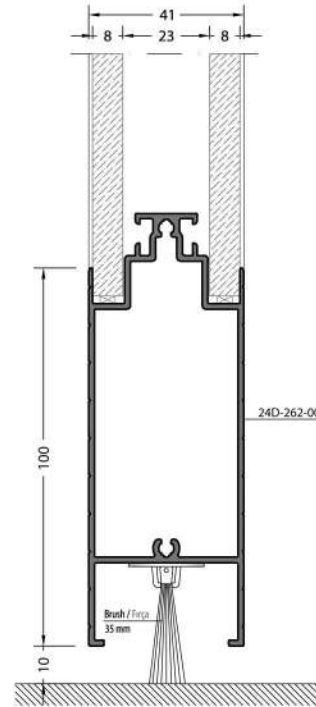
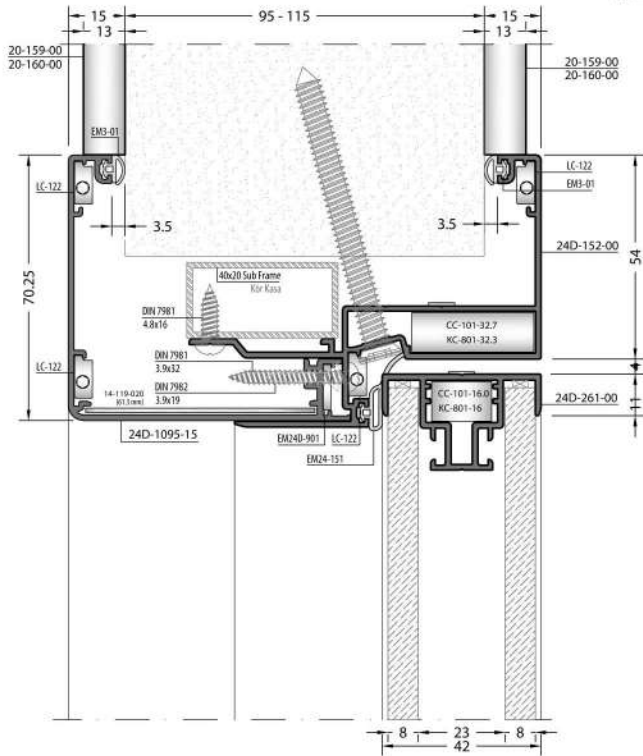
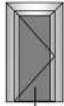
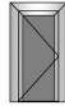
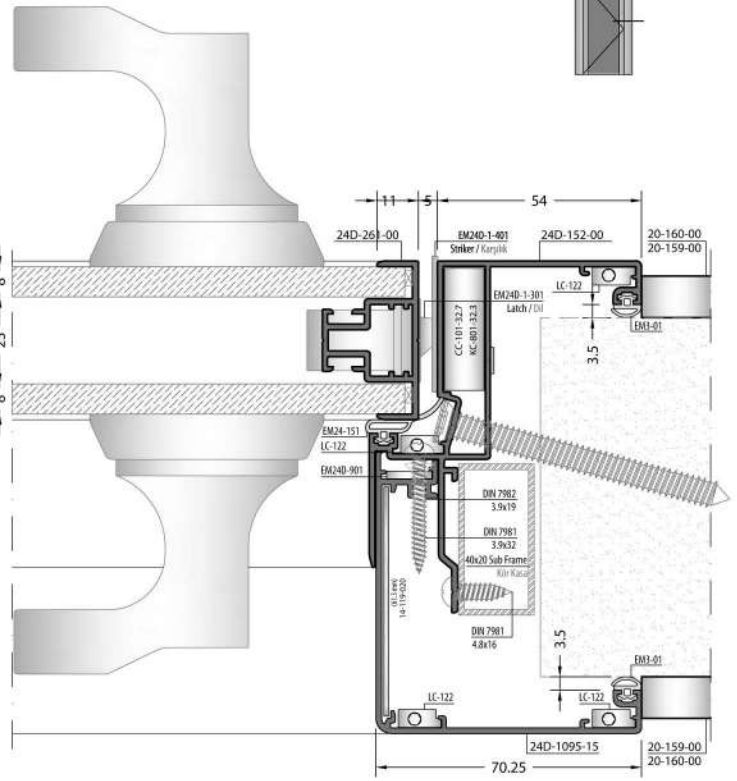
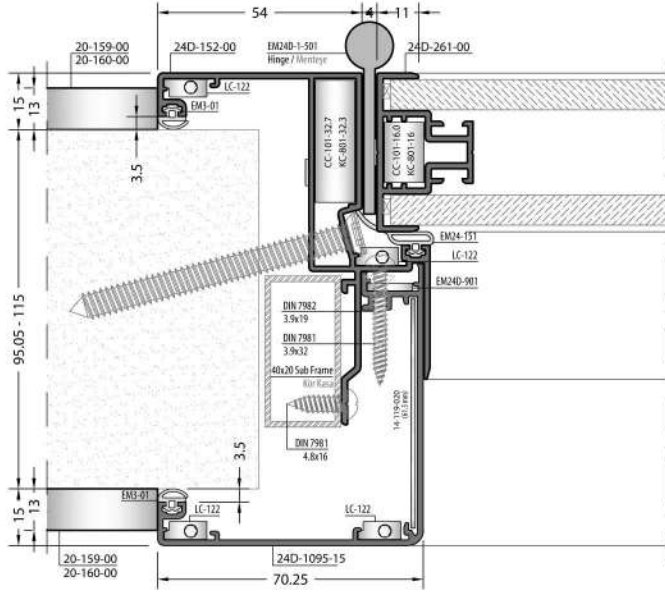

1:2 Scale / 1:2 Ölçek

INTERIOR DOOR SYSTEM / İÇ MEKAN KAPI SİSTEMİ

FLAT FRAME **GLASS DOOR - 8 mm**
DÜZ KASA **CAM KAPI**

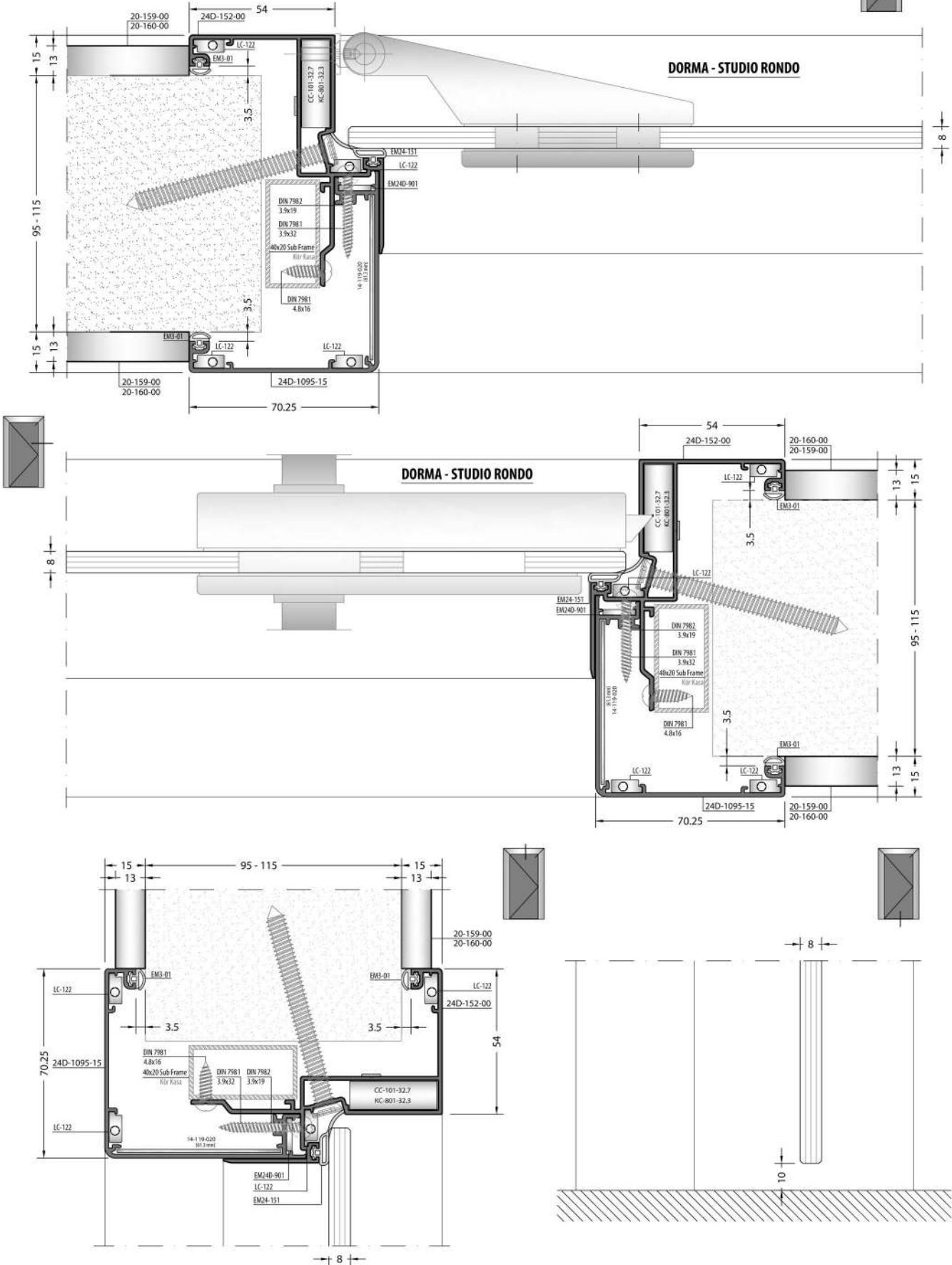

1:2 Scaled / 1:2 Ölçek

APPLICATION OPTIONS / UYGULAMA SEÇENEKLERİ

MONTAGE WITH SUB FRAME / KÖR KASALI MONTAJ

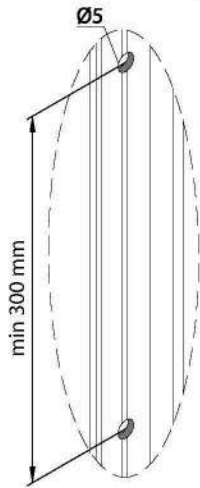
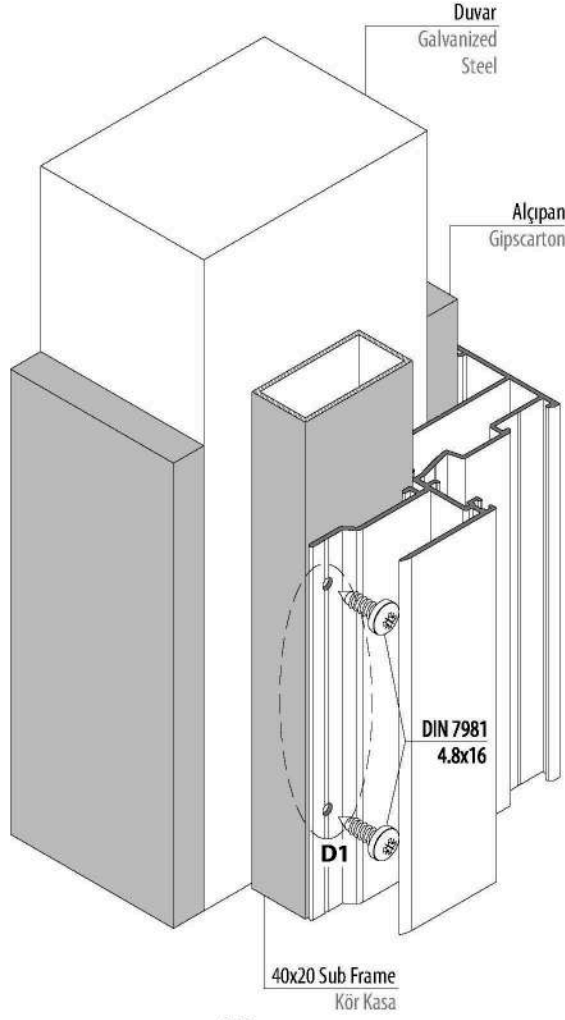

D1 DETAIL / D1 DETAYI

MONTAGE WITHOUT SUB FRAME / KÖR KASASIZ MONTAJ

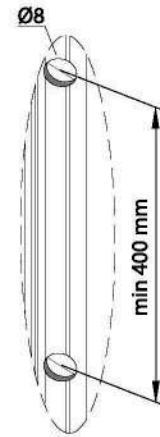
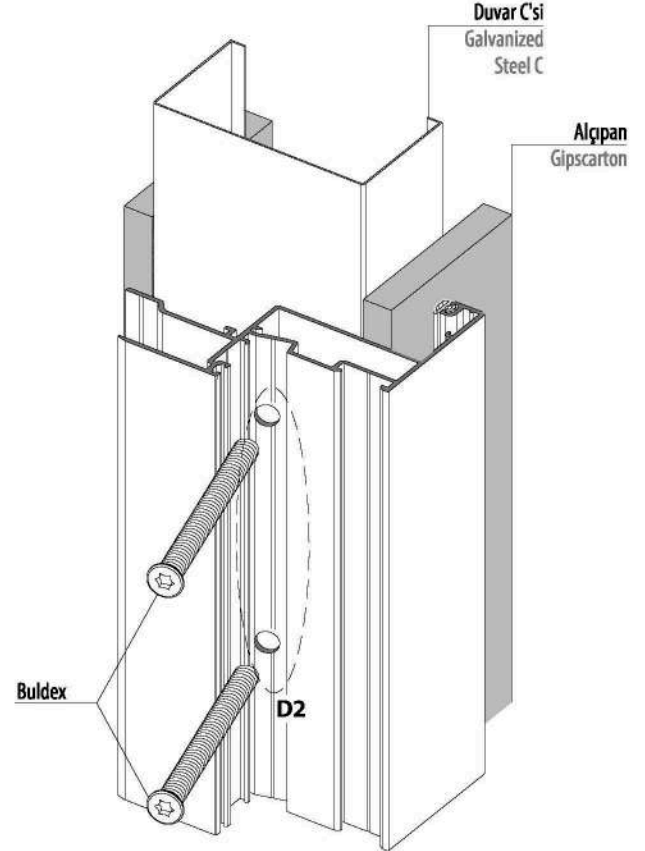

D2 DETAIL / D2 DETAYI

LATCH DRILING DIMENSIONS
DİL FREZELEME ÖLÇÜLERİ

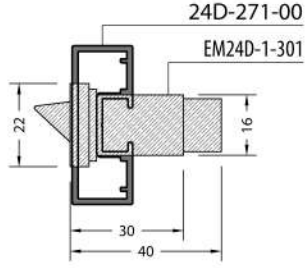

GLASS DRILING DIMENSIONS
CAM DELME ÖLÇÜLERİ

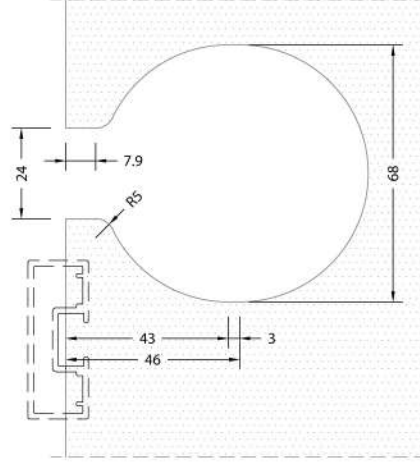

HANDLE COVER PLATE DIMENSIONS
KOL AYNASI ÖLÇÜLERİ

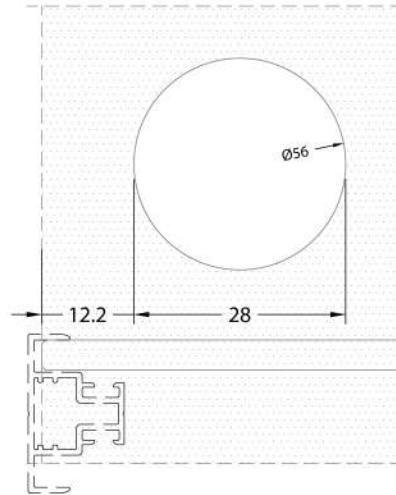
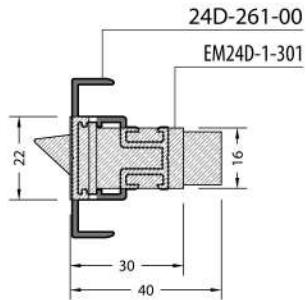
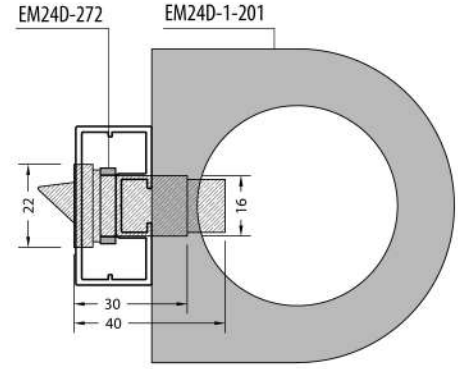
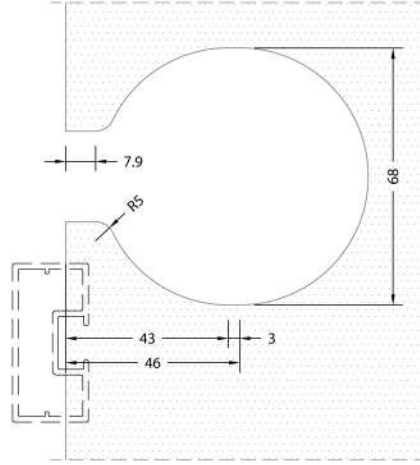
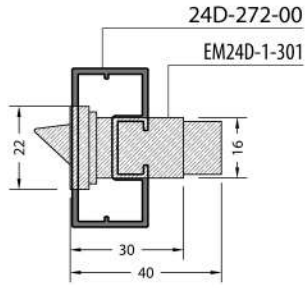
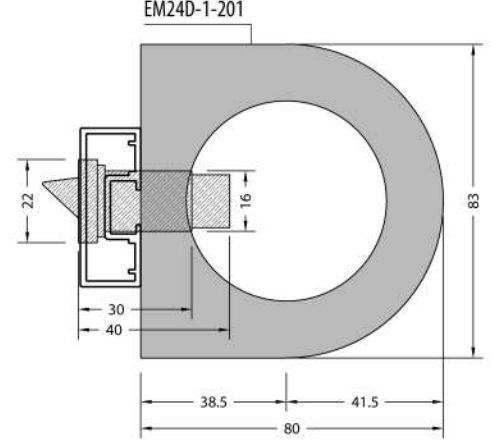

GLASS DOOR - STRIKER ÜDRILING DIMENSIONS
CAM KAPI - KARŞILIK FREZELEME ÖLÇÜLERİ

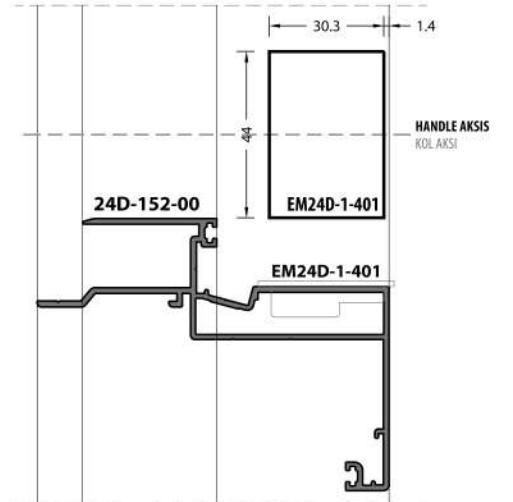

1:2 Scale / 1:2 Ölçek

GLASS DOOR - GLASS DRILING DIMENSIONS
CAM KAPI - CAM DELME ÖLÇÜLERİ

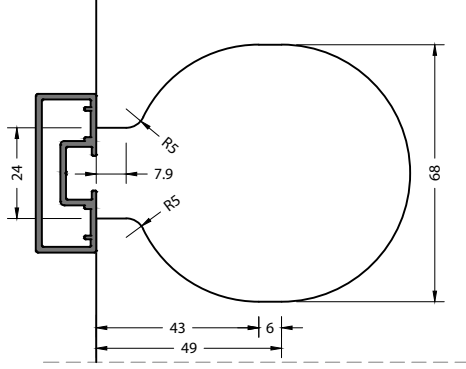

GLASS DOOR - HANDLE COVER PLATE DIMENSIONS
CAM KAPI - KOL AYNASI ÖLÇÜLERİ

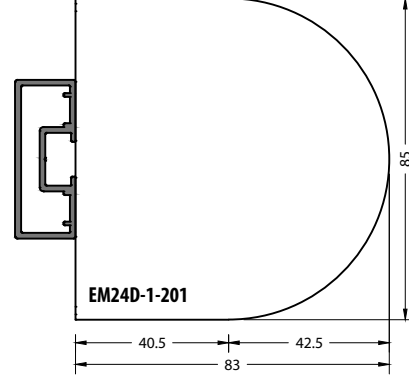

GLASS DOOR - STRIKER DRILING DIMENSIONS
CAM KAPI - KARŞILIK FREZELEME ÖLÇÜLERİ

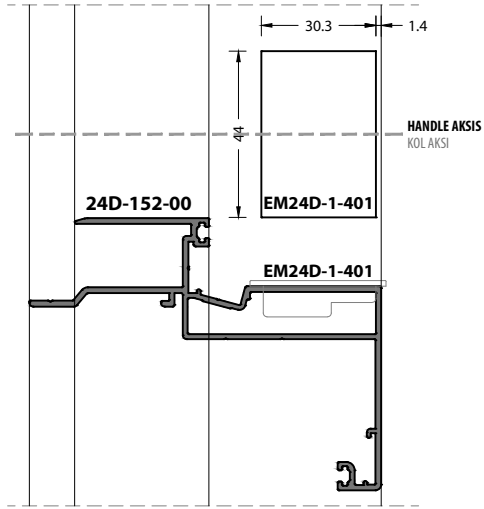

GLASS DOOR - LATCH DRILING DIMENSIONS
CAM KAPI - DİL FREZELEME ÖLÇÜLERİ

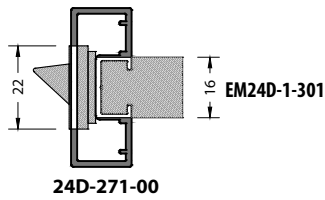

GLASS DOOR - LATCH DRILING DIMENSIONS
CAM KAPI - DİL FREZELEME ÖLÇÜLERİ

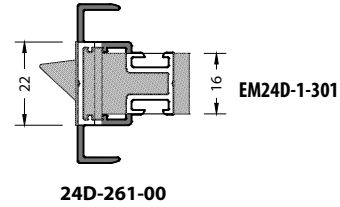

MECANICAL CORNER JOINT DRILING DIMENSIONS
MEKANİK BAĞLANTI DELİK ÖLÇÜLERİ

24D-151-00

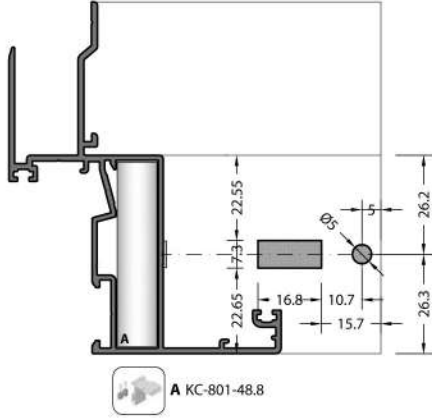

24D-152-00

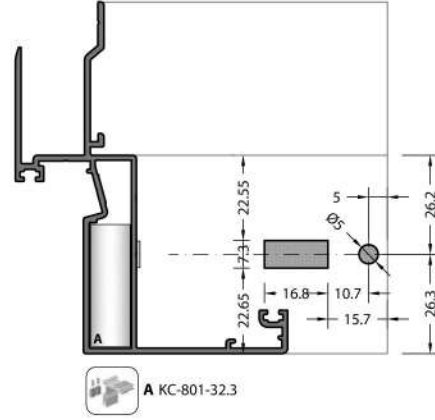

24D-271-00

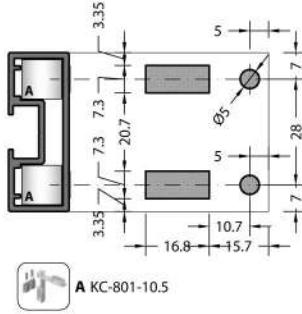



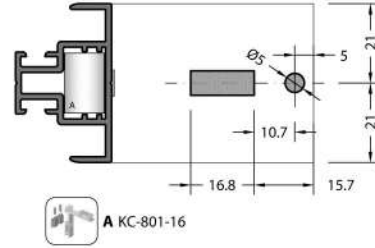

24D-261-00



24D Manuel Punch Machine
24D Manuel Punch Makinası



-  A KC-801-10.5
-  A KC-801-16
-  A KC-801-32.3
-  A KC-801-48.8



KURTOĞLU BAKIR KURŞUN SANAYİ A.Ş.

Velimeşe Organize Sanayi Bölgesi Akbayır Yolu
Küme Evler No: 81 Ergene 59851 Tekirdağ / Türkiye
T: 0 282 684 70 00 F: 0 282 684 70 01
www.kurtogluas.com