

aluteams
Aluminium Profile & Accessory Systems

PRODUCT CATALOGUE
ÜRÜN KATALOĐU

Hakkımızda

ALUTEAMS A.Ş., 2014 yılında İstanbul Çağlayan'da Alüminyum aksesuarları ithalatı ve ihracatı yapmak üzere faaliyete başlamıştır. Şirketimiz özellikle sistem profili üreten firmaların tüm taleplerini karşılayabilecek bir çözüm ortağıdır. Giesse, Ragni, G-U, Siegenia, AA ve Kale gibi dev alüminyum aksesuarları üreticilerinin distribütörlüğünü yapmakta olan ALUTEAMS A.Ş. ithal ettiği ve yerli üreticiden aldığı ürünleri İran, Irak, Gürcistan, Ermenistan, Bulgaristan, Kıbrıs, Afrika gibi birçok ülkeye ihraç etmektedir.

Pazardaki gelişmeleri yakından takip ederek genişlettiğimiz ürün portföyümüzle müşterilerimize hızlı ve etkili çözümler sunmaktayız.

Konusunda uzman personelimiz, yüksek kaliteli ürünlerimiz ile pürüzsüz ilerleyen lojistik o perasyonlarımız sayesinde başarılarımızın sürdürülebilirliğini garanti etmek amacı ile profesyonel hayatımıza devam etmekteyiz.

About Us

ALUTEAMS Co., an aluminum accessories import and export company was founded in 2014 at Istanbul/Turkey. Our company is a business partner that can meet all the demands for system profile producing companies. Being the distributor of Giesse, Ragni, G-U, Siegenia, AA, Kale and significant local producers Aluteams exports their accessories to many countries such as Iran, Iraq, Georgia, Armenia, Bulgaria, Cyprus and Africa.

Expanding our product portfolio by following the developments of the market closely, we are offering fast and efficient solutions to our customers.

Via our personnel with expertise, high quality products and flawless logistic operations, we continue our Professional life aiming to guarantee the sustainability of our successes.



Corner Joints Köşe Bağlantılar
5-16

Hinge Groups Menteşe Grubu
17-23

Window Handles Pencere Kolları
24-31

Door Handles Kapı Kolları
32-35

Pull Handles Çekme Kolları
36-40

Strikers & Latches Sürgü ve Karşılıklar
41-49

Curtain Wall Group Cephe Grubu

50-55

Sliding Accessories Sürme Aksesuarları

56-65

GOS-S Sürme ve Kaldır Sür

66-69

Locks Kilitler

70-75

Hand Tools El Aletleri

76-89

Glass Materials Cam Malzemeler

90-93

Corner Joints

Köşe Bağlantılar



LC-1120-(4561)

Aluminium Corner Joint
Pimli Köşe Bağlantı

| | |
|----------------------------|--------------|
| Width / Genişlik | 19 |
| Height / Yükseklik | 10.5 |
| Quantity/Miktar - Box/Kutu | 250 PCS/Adet |

LC-1123-(4562)

Aluminium Corner Joint
Pimli Köşe Bağlantı

| | |
|----------------------------|--------------|
| Width / Genişlik | 22.5 |
| Height / Yükseklik | 10.5 |
| Quantity/Miktar - Box/Kutu | 250 PCS/Adet |



LC-1125-(4560)

Aluminium Corner Joint
Pimli Köşe Bağlantı

| | |
|----------------------------|--------------|
| Width / Genişlik | 24 |
| Height / Yükseklik | 10.5 |
| Quantity/Miktar - Box/Kutu | 250 PCS/Adet |



LC-1127-(2610)

Aluminium Corner Joint
Pimli Köşe Bağlantı

| | |
|----------------------------|--------------|
| Width / Genişlik | 26 |
| Height / Yükseklik | 10.4 |
| Quantity/Miktar - Box/Kutu | 250 PCS/Adet |



• Corner Joints | Köşe Bağlantılar



LC-2320-(2632)

Aluminium Corner Joint

Pimli Köşe Bağlantı

| | |
|----------------------------|--------------|
| Width / Genişlik | 19 |
| Height / Yükseklik | 12.6 |
| Quantity/Miktar - Box/Kutu | 250 PCS/Adet |

LC-1826-(2618)

Aluminium Corner Joint

Pimli Köşe Bağlantı

| | |
|----------------------------|--------------|
| Width / Genişlik | 25.5 |
| Height / Yükseklik | 17.4 |
| Quantity/Miktar - Box/Kutu | 250 PCS/Adet |



LC-0923-(4563)

Aluminium Corner Joint

Pimli Köşe Bağlantı

| | |
|----------------------------|--------------|
| Width / Genişlik | 22 |
| Height / Yükseklik | 8.3 |
| Quantity/Miktar - Box/Kutu | 250 PCS/Adet |

LC-1840-(4180)

Aluminium Corner Joint

Pimli Köşe Bağlantı

| | |
|----------------------------|--------------|
| Width / Genişlik | 36 |
| Height / Yükseklik | 13.8 |
| Quantity/Miktar - Box/Kutu | 250 PCS/Adet |





LC-3311

Aluminium Corner Joint
Pimli Köşe Bağlantı

| | |
|----------------------------|--------------|
| Width / Genişlik | 32 |
| Height / Yükseklik | 10 |
| Quantity/Miktar - Box/Kutu | 250 PCS/Adet |

LC-174-(2000)

Aluminium Corner Joint
Köşe Gönye Bağlantı

| | |
|----------------------------|--------------|
| Width / Genişlik | 4.8 |
| Height / Yükseklik | 17.4 |
| Quantity/Miktar - Box/Kutu | 500 PCS/Adet |



LC-122-(2013)

Aluminium Corner Joint
Köşe Gönye Bağlantı

| | |
|----------------------------|--------------|
| Width / Genişlik | 4.5 |
| Height / Yükseklik | 11.2 |
| Quantity/Miktar - Box/Kutu | 500 PCS/Adet |

LC-4003

Aluminium Corner Joint
Pimli Köşe Bağlantı

| | |
|----------------------------|--------------|
| Width / Genişlik | 36 |
| Height / Yükseklik | 13.9 |
| Quantity/Miktar - Box/Kutu | 250 PCS/Adet |



• Corner Joints | Köşe Bağlantılar



LC-1142-(4514)

Aluminium Corner Joint
Pimli Köşe Bağlantı

| | |
|----------------------------|--------------|
| Width / Genişlik | 41 |
| Height / Yükseklik | 10 |
| Quantity/Miktar - Box/Kutu | 250 PCS/Adet |

LC-4004

Aluminium Corner Joint
Pimli Köşe Bağlantı

| | |
|----------------------------|--------------|
| Width / Genişlik | 36 |
| Height / Yükseklik | 29.2 |
| Quantity/Miktar - Box/Kutu | 250 PCS/Adet |



LC-4014-(MO-42)

Aluminium Corner Joint
Pimli Köşe Bağlantı

| | |
|----------------------------|--------------|
| Width / Genişlik | 40 |
| Height / Yükseklik | 14 |
| Quantity/Miktar - Box/Kutu | 200 PCS/Adet |

LC-1828-(931)

Aluminium Corner Joint
Pimli Köşe Bağlantı

| | |
|----------------------------|-------------|
| Width / Genişlik | 25 |
| Height / Yükseklik | 17,2 |
| Quantity/Miktar - Box/Kutu | 20 PCS/Adet |





LC-5000

Aluminium Corner Joint
Pimli Köşe Bağlantı

Width / Genişlik

Height / Yükseklik

Quantity/Miktar - Box/Kutu 250 PCS/Adet

LC-2327-(2601-2660)

Aluminium Corner Joint
Pimli Köşe Bağlantı

Width / Genişlik 26

Height / Yükseklik 22.5

Quantity/Miktar - Box/Kutu 200 PCS/Adet



LC-3927-(2630)

Aluminium Corner Joint
Pimli Köşe Bağlantı

Width / Genişlik 26

Height / Yükseklik 38.3

Quantity/Miktar - Box/Kutu 150 PCS/Adet



LC-1327-(2633)

Aluminium Corner Joint
Pimli Köşe Bağlantı

Width / Genişlik 26.5

Height / Yükseklik 12.6

Quantity/Miktar - Box/Kutu 250 PCS/Adet



• Corner Joints | Köşe Bağlantılar



LC-3626 - (2636)

Aluminium Corner Joint
Pimli Köşe Bağlantı

| | |
|----------------------------|--------------|
| Width / Genişlik | 25.2 |
| Height / Yükseklik | 36 |
| Quantity/Miktar - Box/Kutu | 200 PCS/Adet |

LC-4327-(2650)

Aluminium Corner Joint
Pimli Köşe Bağlantı

| | |
|----------------------------|--------------|
| Width / Genişlik | 26 |
| Height / Yükseklik | 42.3 |
| Quantity/Miktar - Box/Kutu | 150 PCS/Adet |



LC-4564

Aluminium Corner Joint
Pimli Köşe Bağlantı

| | |
|----------------------------|--------------|
| Width / Genişlik | 35.8 |
| Height / Yükseklik | 8.3 |
| Quantity/Miktar - Box/Kutu | 250 PCS/Adet |

LC-4700-(1120)

Aluminium Corner Joint
Pimli Köşe Bağlantı

| | |
|----------------------------|--------------|
| Width / Genişlik | 28.5 |
| Height / Yükseklik | 14.5 |
| Quantity/Miktar - Box/Kutu | 250 PCS/Adet |





LC-1118 - (4715)

Aluminium Corner Joint
Pimli Köşe Bağlantı

| | |
|----------------------------|--------------|
| Width / Genişlik | 18 |
| Height / Yükseklik | 10.4 |
| Quantity/Miktar - Box/Kutu | 250 PCS/Adet |

AK-36

Aluminium Corner Joint
Pimli Köşe Bağlantı

| | |
|----------------------------|---------------|
| Width / Genişlik | |
| Height / Yükseklik | |
| Quantity/Miktar - Box/Kutu | 1000 PCS/Adet |



LC-3511 - (1168)

Aluminium Corner Joint
Pimli Köşe Bağlantı

| | |
|----------------------------|--------------|
| Width / Genişlik | 34 |
| Height / Yükseklik | 10.6 |
| Quantity/Miktar - Box/Kutu | 250 PCS/Adet |

LC-4339 - (3516) (MO 43)

Aluminium Corner Joint
Pimli Köşe Bağlantı

| | |
|----------------------------|--------------|
| Width / Genişlik | 38 |
| Height / Yükseklik | 42 |
| Quantity/Miktar - Box/Kutu | 100 PCS/Adet |



• Corner Joints | Köşe Bağlantılar



LC-1141 - (00350000)

Aluminium Corner Joint

Pimli Köşe Bağlantı

| | |
|----------------------------|--------------|
| Width / Genişlik | 40 |
| Height / Yükseklik | 10 |
| Quantity/Miktar - Box/Kutu | 250 PCS/Adet |

02923000 (Gos-s)

Aluminium Corner Joint

Pimli Köşe Bağlantı

| | |
|----------------------------|--------------|
| Width / Genişlik | |
| Height / Yükseklik | |
| Quantity/Miktar - Box/Kutu | 100 PCS/Adet |



AL-101 (Mobilya)

Aluminium Corner Joint

Alüminyum Köşe Bağlantı

| | |
|----------------------------|--------------|
| Width / Genişlik | 42 |
| Height / Yükseklik | 3 |
| Quantity/Miktar - Box/Kutu | 500 PCS/Adet |

AL-100 (Mobilya)

L Corner Joint

Metal Köşe Bağlantı

| | |
|----------------------------|--------------|
| Width / Genişlik | |
| Height / Yükseklik | |
| Quantity/Miktar - Box/Kutu | 500 PCS/Adet |





AK-605 (Aldoks)

Galvanized Corner Joint
Metal Köşe Bağlantı

Width / Genişlik

Height / Yükseklik

Quantity/Miktar - Box/Kutu 250 PCS/Adet

LC-107

L Corner Joint
Metal Köşe Gönye

Width / Genişlik 7mm

Height / Yükseklik 1mm

Quantity/Miktar - Box/Kutu 1000 PCS/Adet



MK-19

L Corner Joint
Metal Köşe Gönye

Width / Genişlik 5mm

Height / Yükseklik 1mm

Quantity/Miktar - Box/Kutu 1000 PCS/Adet

MO 20.1

L Corner Joint
Metal Köşe Gönye

Width / Genişlik 14mm

Height / Yükseklik 0.8mm

Quantity/Miktar - Box/Kutu 1000 PCS/Adet



EM24-101

L Corner Joint
Metal Köşe Bağlantı

Width / Genişlik 19.26mm

Height / Yükseklik 1,5mm

Quantity/Miktar - Box/Kutu 500 PCS/Adet

• Corner Joints | Köşe Bağlantılar



P-100.1

Middle Joint

Metal Orta Kayıt Bağlantı

| | |
|----------------------------|---------------|
| Width / Genişlik | 17.8mm-13.9mm |
| Height / Yükseklik | 2mm |
| Quantity/Miktar - Box/Kutu | 250 PCS/Adet |

PK-20

Plastic Corner Joint

Metal Köşe Gönye

| | |
|----------------------------|---------------|
| Width / Genişlik | 15.3mm |
| Height / Yükseklik | 3mm |
| Quantity/Miktar - Box/Kutu | 1000 PCS/Adet |

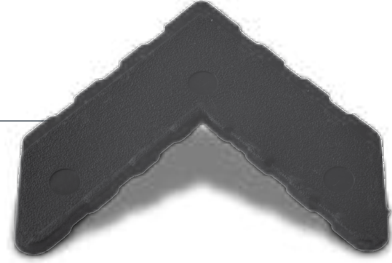

27A 2101

L Corner Joint

Metal Köşe Bağlantı

| | |
|----------------------------|--------------|
| Width / Genişlik | 32mm |
| Height / Yükseklik | 2.5mm |
| Quantity/Miktar - Box/Kutu | 500 PCS/Adet |

AT-219

Steel Corner Joint

Metal Köşe Bağlantı

| | |
|----------------------------|--------------|
| Width / Genişlik | |
| Height / Yükseklik | |
| Quantity/Miktar - Box/Kutu | 100 PCS/Adet |

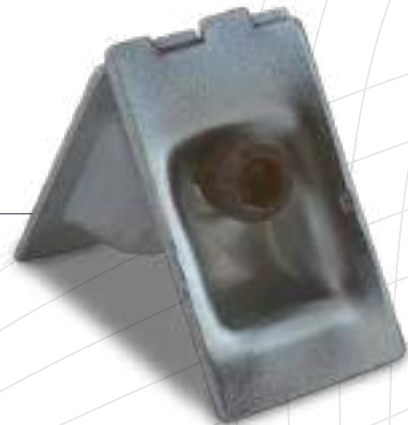



LC-4-8

Pin
Pim

Width / Genişlik

Height / Yükseklik

Quantity/Miktar - Box/Kutu 1000 PCS/Adet

AK-604

C-60 Steel Middle Joint
C-60 Metal Orta Kayıt Bağlantı

Width / Genişlik

Height / Yükseklik

Quantity/Miktar - Box/Kutu 100 PCS/Adet

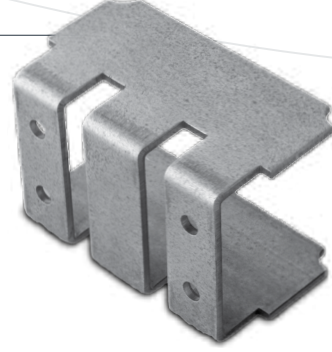

AK-602

Steel Middle Joint
Çelik Ortakayıt Bağlantı

Width / Genişlik

Height / Yükseklik

Quantity/Miktar - Box/Kutu 100 PCS/Adet



24-102

L Corner Joint
Metal Köşe Bağlantı

Width / Genişlik 24.74mm

Height / Yükseklik 1,5mm

Quantity/Miktar - Box/Kutu 500 PCS/Adet



AK-603

Steel Middle Joint
Çelik Ortakayıt Bağlantı

Width / Genişlik

Height / Yükseklik

Quantity/Miktar - Box/Kutu 100 PCS/Adet



900-36

Galvanized Corner Joint
Metal Köşe Bağlantı

Width / Genişlik

Height / Yükseklik

Quantity/Miktar - Box/Kutu 200 PCS/Adet



Hinge Groups

Menteşe Grubu



2106

Window Hinge - (Euro Groove)
Pencere Menteseşi

Quantity/Miktar - Box/Kutu 50 PCS/Adet

2107

Window Hinge - (Euro Groove)
Pencere Menteseşi

Quantity/Miktar - Box/Kutu 50 PCS/Adet



2109 (Algeria)

Window Hinge
Pencere Menteseşi

Quantity/Miktar - Box/Kutu 100 PCS/Adet

2110

Door and Window Hinge - (Euro Groove)
Kapi ve Pencere Menteseşi

Quantity/Miktar - Box/Kutu 100 PCS/Adet



• Hinge Groups | Mentefe Grubu



2114

Window Hinge - (Euro Groove)
Pencere Mentefe

Quantity/Miktar - Box/Kutu 100 PCS/Adet

2118

Door Hinge - (Euro Groove)
Kapi Mentefe

Quantity/Miktar - Box/Kutu 50 PCS/Adet



Giese 00600N

Window Hinge - (Euro Groove)
Pencere Mentefe

Quantity/Miktar - Box/Kutu 20 PCS/Adet

Giese 00120500U

Window Hinge - (Euro Groove)
Pencere Mentefe

Quantity/Miktar - Box/Kutu 20 PCS/Adet





C60 Takozlu

Door Hinge
Kapi Mentese

Quantity/Miktar - Box/Kutu 50 PCS/Adet

Ragni 3003.5

Window Hinge - (Euro Groove)
Pencere Mentese

Quantity/Miktar - Box/Kutu 50 PCS/Adet



Ragni 3300

Door Hinge - (Euro Groove)
Kapi Mentese

Quantity/Miktar - Box/Kutu 20 PCS/Adet

Ragni 3310

Door Hinge - (Euro Groove)
Kapi Mentese

Quantity/Miktar - Box/Kutu 10 PCS/Adet



• Hinge Groups | Menteşer Grubu



C-60Y

Door Hinge
Kapı Menteşesi

Quantity/Miktar - Box/Kutu 50 PCS/Adet

2120 (Tunis)

Window Hinge
Pencere Menteşesi

Quantity/Miktar - Box/Kutu 100 PCS/Adet



LH26-150

Window & Door Hinge (PVC Groove)
Pencere ve Kapı Menteşesi (PVC Kanallı)

Quantity/Miktar - Box/Kutu 50 PCS/Adet

2111

Window & Door Hinge
Pencere ve Kapı Menteşesi

Quantity/Miktar - Box/Kutu 50 PCS/Adet





Giesse 00535

Door Hinge - (Euro Groove)
Kapı Mentşesi

Quantity/Miktar - Box/Kutu 10 PCS/Adet

Giesse 06170

Door Hinge
Kapı Mentşesi

Quantity/Miktar - Box/Kutu 10 PCS/Adet



2119 (Libya)

Window Hinge
Pencere Mentşesi

Quantity/Miktar - Box/Kutu 100 PCS/Adet

Ragni 3360

Door Hinge
Kapı Mentşesi

Quantity/Miktar - Box/Kutu 10 PCS/Adet



• Hinge Groups | Mentefe Grubu

AK-102

Window Hinge - (Aldoks)
Pencere Mentefeſi

Quantity/Miktar - Box/Kutu 200 PCS/Adet



AK-102 P

Window Hinge - (Aldoks)
Pencere Mentefeſi

Quantity/Miktar - Box/Kutu 200 PCS/Adet

AK-100

Window Hinge - (Aldoks)
Pencere Mentefeſi

Quantity/Miktar - Box/Kutu 200 PCS/Adet



IÇEL 36

Swinging Door Hinge
Çarpma Kapı Mentefeſi

Quantity/Miktar - Box/Kutu 15 PCS/Adet

IÇEL 33

Swinging Door Hinge
Çarpma Kapı Mentefeſi

Quantity/Miktar - Box/Kutu 25 PCS/Adet



Window Handles

Pencere Kolları

• Window Handles | Pencere Kolları



AA 6001

Cremone Handle
Pencere Kolu

Quantity/Miktar - Box/Kutu 40 PCS/Adet

AA 6002

Cremone Handle
Pencere Kolu

Quantity/Miktar - Box/Kutu 40 PCS/Adet



AK-315

Cremone Handle
Pencere Kolu

Quantity/Miktar - Box/Kutu 120 PCS/Adet

ART 173

Cremone Handle
Pencere Kolu

Quantity/Miktar - Box/Kutu 20 PCS/Adet





ART 195.3

Cremone Handle
Pencere Kolu

Quantity/Miktar - Box/Kutu 20 PCS/Adet

ERA 6011

Cremone Handle
Pencere Kolu

Quantity/Miktar - Box/Kutu 20 PCS/Adet



ERA 6012

Cremone Handle
Pencere Kolu

Quantity/Miktar - Box/Kutu 20 PCS/Adet

RAGNI 185C

Cremone Handle With Key
Anahtarlı Pencere Kolu

Quantity/Miktar - Box/Kutu 20 PCS/Adet



• Window Handles | Pencere Kolları

RAGNİ 185.3

Cremone Handle
Pencere Kolu

Quantity/Miktar - Box/Kutu 20 PCS/Adet



RAGNİ 185

Cremone Handle
Pencere Kolu

Quantity/Miktar - Box/Kutu 20 PCS/Adet

ERA 282

Cremone Handle (Outward Opening)
Pencere Kolu

Quantity/Miktar - Box/Kutu 50 PCS/Adet



RAGNİ 181.1

Window Handle
Pencere Kolu

Quantity/Miktar - Box/Kutu 20 PCS/Adet



RAGNİ 8000/BL (Euro Groove)

Tilt & Turn Mechanism
Çift Açılım Mekanizması

Width/Genişlik 512mm - 1300mm

Height/Yükseklik 600mm - 2100mm

Quantity/Miktar - Box/Kutu 10 PCS/Adet

RAGNİ 8000/BC (Euro Groove)

Tilt & Turn Mechanism
Çift Açılım Mekanizması

Width/Genişlik 361mm - 511mm

Height/Yükseklik 600mm - 2100mm

Quantity/Miktar - Box/Kutu 10 PCS/Adet

• Tilt & Turn Mechanisms | Çift Açılımlı Mekanizmalar



RAGNİ 8000/C-BL (Euro Groove)

Tilt & Turn Mechanism
Çift Açılım Mekanizması

Width/Genişlik 512mm - 1300mm

Height/Yükseklik 600mm - 2100mm

Quantity/Miktar - Box/Kutu 10 PCS/Adet



RAGNİ 8000/C-BC (Euro Groove)

Tilt & Turn Mechanism
Çift Açılım Mekanizması

Width/Genişlik 361mm - 511mm

Height/Yükseklik 600mm - 2100mm

Quantity/Miktar - Box/Kutu 10 PCS/Adet



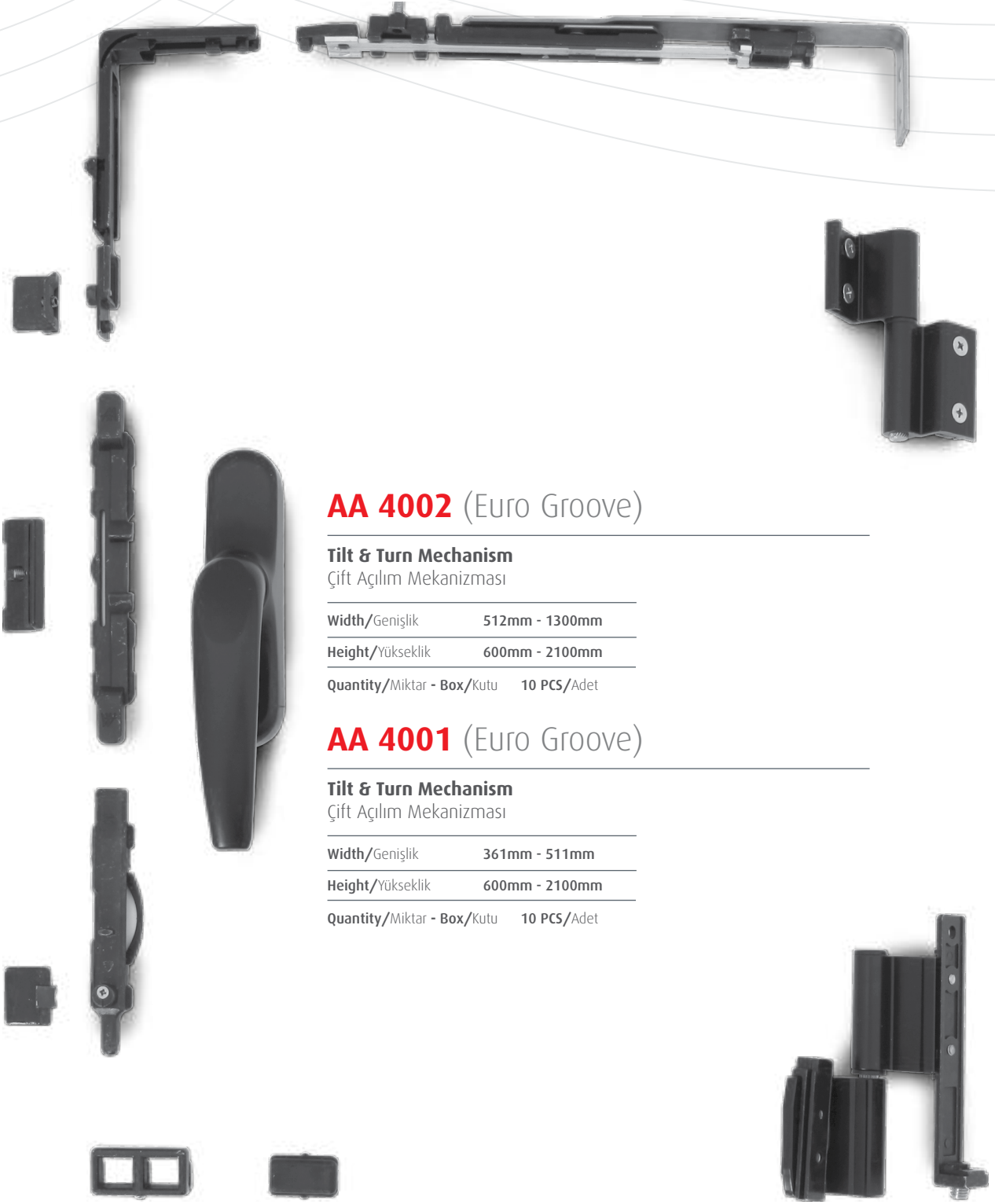

AA 4002 (Euro Groove)

Tilt & Turn Mechanism
Çift Açılım Mekanizması

Width/Genişlik 512mm - 1300mm

Height/Yükseklik 600mm - 2100mm

Quantity/Miktar - Box/Kutu 10 PCS/Adet

AA 4001 (Euro Groove)

Tilt & Turn Mechanism
Çift Açılım Mekanizması

Width/Genişlik 361mm - 511mm

Height/Yükseklik 600mm - 2100mm

Quantity/Miktar - Box/Kutu 10 PCS/Adet

• Tilt & Turn Mechanisms | Çift Açılımlı Mekanizmalar

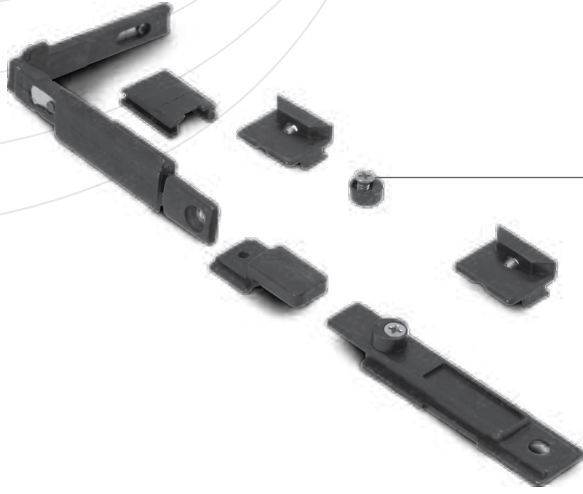

RAGNI 8013

Additional Vertical Lock
İlave Arka Kilitleme

Height/Yükseklik 1300mm - 2100mm

Quantity/Miktar - Box/Kutu 10 PCS/Adet

AA 4001-P

Additional Vertical Lock
İlave Arka Kilitleme

Height/Yükseklik 1300mm - 2100mm

Quantity/Miktar - Box/Kutu 10 PCS/Adet



RAGNI 0011

One Way Mechanism
Tek Yön Mekanizma

Quantity/Miktar - Box/Kutu 20 PCS/Adet

RAGNI 0014

Double Way Mechanism
Çift Yön Mekanizma

Quantity/Miktar - Box/Kutu 20 PCS/Adet



Door Handles

Kapı Kolları

• Door Handles | Kapı Kolları



AA 6105

Door Handle
Kapı Kolu

Width / Genişlik 30 PCS/Adet

ERA 6106

Door Handle
Kapı Kolu

Quantity/Miktar - Box/Kutu 10 PCS/Adet



GIESSE 07050500V

Door Handle
Kapı Kolu

Width / Genişlik 10 PCS/Adet



RAGNİ 201-224

Door Handle
Kapı Kolu

Quantity/Miktar - Box/Kutu 20 PCS/Adet





RAGNİ 227-224

Door Handle
Kapı Kolu

Width / Genişlik 20 PCS/Adet

RAGNİ 228-224

Door Handle
Kapı Kolu

Quantity/Miktar - Box/Kutu 20 PCS/Adet



2080

Door Handle
Kapı Kolu

Width / Genişlik 10 PCS/Adet

3550

Door Handle
Kapı Kolu

Quantity/Miktar - Box/Kutu 10 PCS/Adet



• Door Handles | Kapı Kolları



6125

Door Handle
Kapı Kolu

Width / Genişlik 10 PCS/Adet

6126

Door Handle
Kapı Kolu

Quantity/Miktar - Box/Kutu 10 PCS/Adet



AK-801

Door Handle
Kapı Kolu

Width / Genişlik 50 PCS/Adet



6130

Door Handle
Kapı Kolu

Quantity/Miktar - Box/Kutu 10 PCS/Adet



Pull Handles

Çekme Kolları

• Pull Handles | Çekme Kollar



AK-23

Pull Handle
Çekme Kol

Quantity/Miktar - Box/Kutu 10 PCS/Adet

| Kod / Code | Ø | H |
|------------|------|------|
| AK-23-20 | 25mm | 20cm |
| AK-23-25 | 25mm | 25cm |
| AK-23-30 | 25mm | 30cm |

AK-20

Pull Handle
Çekme Kol

Quantity/Miktar - Box/Kutu 10 PCS/Adet

| Kod / Code | Ø | H |
|------------|------|------|
| AK-20 | 25mm | 20cm |
| AK-30 | 25mm | 30cm |
| AK-40 | 25mm | 40cm |



AK-2020

Pull Handle
Çekme Kol

Quantity/Miktar - Box/Kutu 10 PCS/Adet

| Kod / Code | Ø | H |
|------------|------|------|
| AK-2020-30 | 30mm | 30cm |
| AK-2020-35 | 30mm | 35cm |
| AK-2020-40 | 30mm | 40cm |

AK-22

Pull Handle
Çekme Kol

Quantity/Miktar - Box/Kutu 10 PCS/Adet

| Kod / Code | Ø | H |
|------------|------|------|
| AK-22-20 | 25mm | 20cm |
| AK-22-25 | 25mm | 25cm |
| AK-22-30 | 25mm | 30cm |



YAY-KOL

Pull Handle
Çekme Kol

Quantity/Miktar - Box/Kutu 10 PCS/Adet

| Kod / Code | Ø | H |
|------------|------|------|
| AK-50Y | 30mm | 50cm |
| AK-60Y | 30mm | 60cm |
| AK-70Y | 30mm | 70cm |



H-KOL

Pull Handle
Çekme Kol

Quantity/Miktar - Box/Kutu 10 PCS/Adet

| Kod / Code | Ø | H |
|------------|------|------|
| AK-50H | 30mm | 50cm |
| AK-60H | 30mm | 60cm |
| AK-70H | 30mm | 70cm |

AK-2021

Pull Handle
Çekme Kol

Quantity/Miktar - Box/Kutu 10 PCS/Adet

| Kod / Code | Ø | H |
|------------|------|------|
| AK-2021-30 | 30mm | 30cm |
| AK-2021-35 | 30mm | 35cm |
| AK-2021-40 | 30mm | 40cm |



AK-21

Pull Handle
Çekme Kol

Quantity/Miktar - Box/Kutu 10 PCS/Adet

| Kod / Code | Ø | H |
|------------|------|------|
| AK-21-20 | 25mm | 20cm |
| AK-21-30 | 25mm | 30cm |
| AK-21-40 | 25mm | 40cm |

• Pull Handles | Çekme Kollar



AK-110

Pull Handle
Çekme Kol

Quantity/Miktar - Box/Kutu 10 PCS/Adet

| Kod / Code | Ø | H |
|------------|------|-------|
| AK-110-90 | 25mm | 90cm |
| AK-110-100 | 25mm | 100cm |
| AK-110-120 | 25mm | 120cm |

AK-220

Pull Handle
Çekme Kol

Quantity/Miktar - Box/Kutu 10 PCS/Adet

| Kod / Code | Ø | H |
|------------|-----|-------|
| AK-220-90 | 8mm | 90cm |
| AK-220-100 | 8mm | 100cm |
| AK-220-120 | 8mm | 120cm |



AK-2025

Pull Handle
Çekme Kol

Quantity/Miktar - Box/Kutu 10 PCS/Adet

AK-2026

Pull Handle
Çekme Kol

Quantity/Miktar - Box/Kutu 10 PCS/Adet



AK-15

Pull Handle
Çekme Kol

Quantity/Miktar - Box/Kutu 10 PCS/Adet

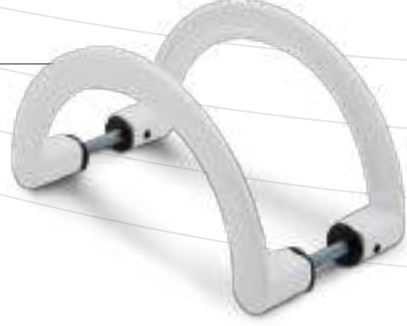

AK-10

Pull Handle
Çekme Kol

Quantity/Miktar - Box/Kutu 100 PCS/Adet

AK-210

Pull Handle
Çekme Kol

Quantity/Miktar - Box/Kutu 100 PCS/Adet



C-010

Pull Handle
Çekme Kol

Quantity/Miktar - Box/Kutu 100 PCS/Adet

Strikers & Latches

Sürgü ve Karşılıklar

3208 (Euro Groove)

Latches
Sürgü

Length/Uzunluk 24cm

Quantity/Miktar - Box/Kutu 120 PCS/Adet



3208-K (Euro Groove)

Latches
Sürgü

Length/Uzunluk 17cm

Quantity/Miktar - Box/Kutu 120 PCS/Adet



2013

Latches
Sürgü

Length/Uzunluk 24cm

Quantity/Miktar - Box/Kutu 120 PCS/Adet



2013-K

Latches
Sürgü

Length/Uzunluk 17cm

Quantity/Miktar - Box/Kutu 120 PCS/Adet



3203 (Euro Groove)

Latches
Sürgü

Quantity/Miktar - Box/Kutu 120 PCS/Adet

• Latches | Sürgüler

AK-540

Latches
Sürgü

Quantity/Miktar - Box/Kutu 120 PCS/Adet



AK-545

Latches
Sürgü

Quantity/Miktar - Box/Kutu 120 PCS/Adet



3204 (Euro Groove)

Window Locking Mechanism
Pencere Kilitleme Mekanizması

Quantity/Miktar - Box/Kutu 120 PCS/Adet



3204-H (Euro Groove)

Window Locking Mechanism
Pencere Kilitleme Mekanizması

Quantity/Miktar - Box/Kutu 120 PCS/Adet

LR-163

Stoper
Stoper

Quantity/Miktar - Box/Kutu 120 PCS/Adet



GIESSE 0219000 (Euro Groove)

Latches
Sürgü

Quantity/Miktar - Box/Kutu 10 PCS/Adet

GIESSE 01704500 (Euro Groove)

Finger Catch
Vasistas Çit Çit

Quantity/Miktar - Box/Kutu 20 PCS/Adet



555 (Euro Groove)

Finger Catch
Vasistas Çit Çit

Quantity/Miktar - Box/Kutu 30 PCS/Adet



3209

Finger Catch
Vasistas Çit Çit

Quantity/Miktar - Box/Kutu 100 PCS/Adet



AK-530

Finger Catch
Vasistas Çit Çit

Quantity/Miktar - Box/Kutu 100 PCS/Adet



ART-121 (Euro Groove)

Universal Lock
Emniyet Kilidi

Quantity/Miktar - Box/Kutu 20 PCS/Adet



ART-550 (Euro Groove)

Finger Catch
Vasistas Çit Çit

Quantity/Miktar - Box/Kutu 20 PCS/Adet



• Vasistas Arms | Vasistas Makaslar

0140L (24cm) (Euro Groove)

Vasistas Opening Mechanism
Vasistas Makası

Quantity/Miktar - Box/Kutu 20 PCS/Adet



0140C (14cm) (Euro Groove)

Vasistas Opening Mechanism
Vasistas Makası

Quantity/Miktar - Box/Kutu 20 PCS/Adet

3207 (22cm) (Euro Groove)

Vasistas Opening Mechanism
Vasistas Makası

Quantity/Miktar - Box/Kutu 20 PCS/Adet

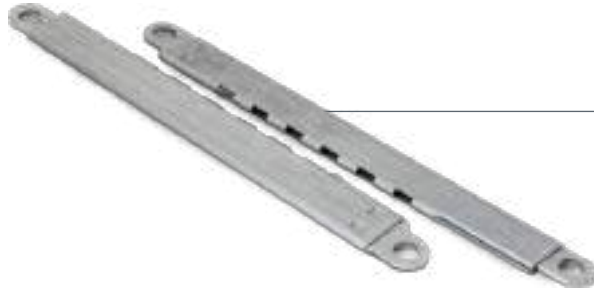

1275

Adjustable Opening Mechanism
Kademeli Makas (5 Kademe)

Quantity/Miktar - Box/Kutu 10 Kit/Takım

AK-513 (13cm)

Vasistas Opening Mechanism
Vasistas Makası

Quantity/Miktar - Box/Kutu 50 PCS/Adet

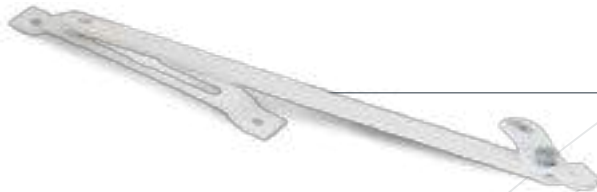

AK-522 (22cm)

Vasistas Opening Mechanism
Vasistas Makası

Quantity/Miktar - Box/Kutu 50 PCS/Adet



SCARABEO 2953 (Euro Groove Alm)

Vasistas High Opening System
Vasistas Yüksek Açılım Sistemi

Width/Genişlik 700mm Max.

Height/Yükseklik 600mm Max.

Quantity/Miktar - Box/Kutu 10 PCS/Adet



SCARABEO 2998 (PVC)

Vasistas High Opening System
Vasistas Yüksek Açılım Sistemi

Width/Genişlik 700mm Max.

Height/Yükseklik 600mm Max.

Quantity/Miktar - Box/Kutu 10 PCS/Adet



KR-01D (Euro Groove)

Striker For Door
Kapı Kilit Karşılığı

Quantity/Miktar - Box/Kutu 100 PCS/Adet



KR-02M (Euro Groove)

Striker For Door
Kapı Kilit Karşılığı

Quantity/Miktar - Box/Kutu 100 PCS/Adet

AK-202M

Striker For Door
Kapı Kilit Karşılığı

Quantity/Miktar - Box/Kutu 100 PCS/Adet

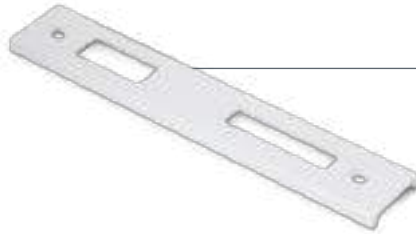

AK-202D

Striker For Door
Kapı Kilit Karşılığı

Quantity/Miktar - Box/Kutu 100 PCS/Adet

C-60M

Striker For Door
Kapı Kilit Karşılığı

Quantity/Miktar - Box/Kutu 100 PCS/Adet



C-60D

Striker For Door
Kapı Kilit Karşılığı

Quantity/Miktar - Box/Kutu 100 PCS/Adet

• Strikers & Pins | Karşılık ve Pimler

0153 (Euro Groove)

Adjustable Pin
Ayarlı Pim

120 PCS/Adet



0154 (Euro Groove)

Striker
Karşılık

Quantity/Miktar - Box/Kutu 100 PCS/Adet

AK-328

Adjustable Striker
Ayarlı Karşılık

Quantity/Miktar - Box/Kutu 100 PCS/Adet



AK-329 (Euro Groove)

Adjustable Striker
Ayarlı Karşılık

Quantity/Miktar - Box/Kutu 100 PCS/Adet

245A

Pin
Pim

Quantity/Miktar - Box/Kutu 100 PCS/Adet



245B

Pin
Pim

Quantity/Miktar - Box/Kutu 100 PCS/Adet

Curtain Wall Group

Cephe Grubu

• Curtain Wall Group | Cephe Grubu

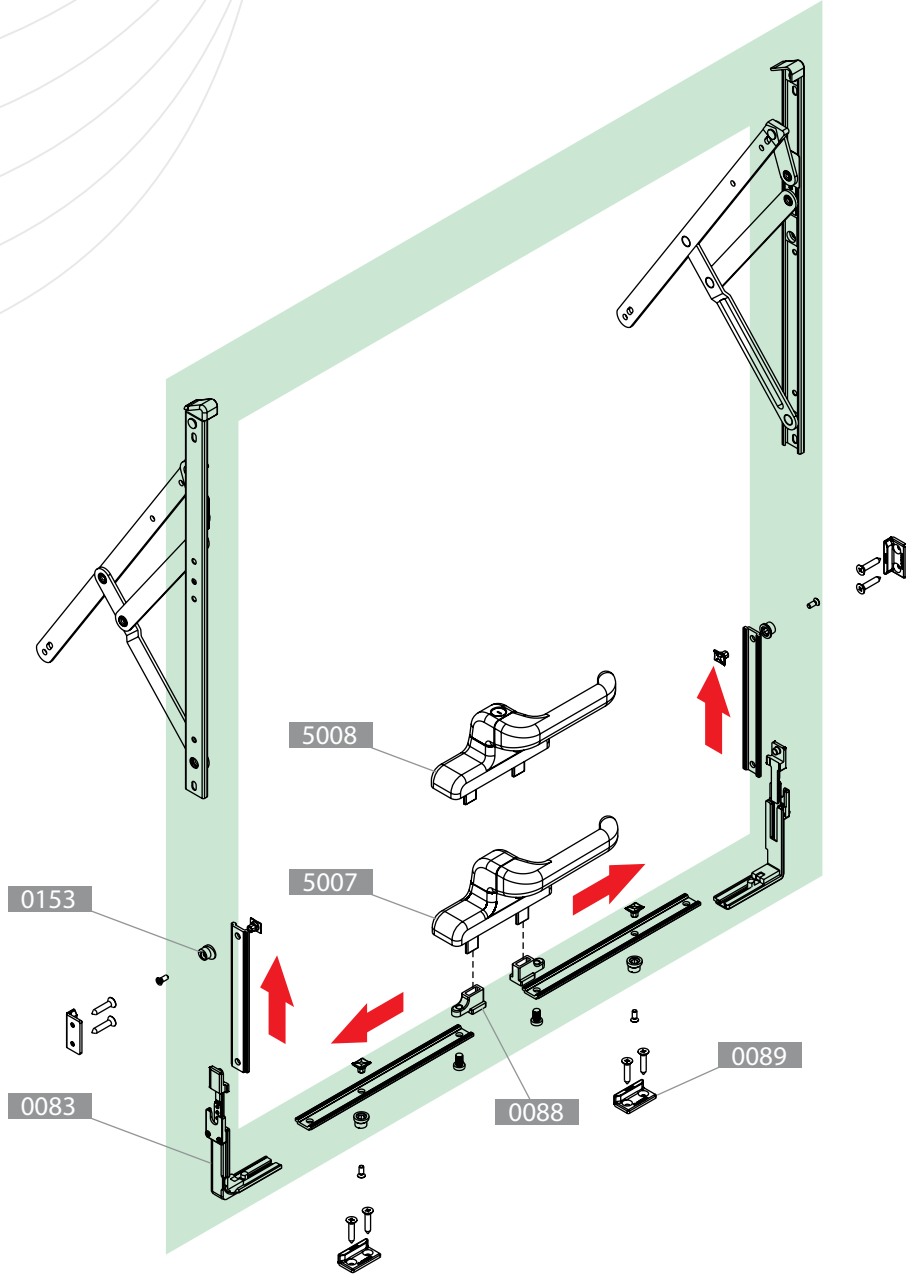

| GS HD "P" TİPİ | | | | | | | KANAT ÖLÇÜLERİ | | |
|--------------------|-----------|--------------|----------------------|----------------------|---------------------|---------------------|-----------------------------|----------------------------|---------------------------|
| MAKAS TİPİ | Ürün Kodu | Açılım Şekli | Makas Genişliği (mm) | Çalışma Boşluğu (mm) | Makas Uzunluğu (mm) | Maks. Açma Derecesi | Maks. Kanat Yüksekliği (mm) | Maks. Kanat Genişliği (mm) | Maks. Kanat Ağırlığı (mm) |
| GS HD - 14" P Tipi | 08536000N | Gizli Kanat | 23 | 16+0,5 | 353,5 | 30°/35° | 1000 | 1300 | 69,5 |
| GS HD - 16" P Tipi | 08537000N | Gizli Kanat | 23 | 16+0,5 | 414,5 | 25°/30° | 1200 | 1400 | 88,5 |
| GS HD - 18" P Tipi | 08538000N | Gizli Kanat | 23 | 16+0,5 | 458,5 | 25°/30° | 1400 | 1400 | 102 |
| GS HD - 20" P Tipi | 08539000N | Gizli Kanat | 23 | 16+0,5 | 511,5 | 20°/25° | 1600 | 1500 | 135 |
| GS HD - 22" P Tipi | 08540000N | Gizli Kanat | 23 | 16+0,5 | 556,5 | 20°/25° | 1700 | 1500 | 137 |
| GS HD - 24" P Tipi | 08541000N | Gizli Kanat | 23 | 16+0,5 | 602,5 | 20°/25° | 1800 | 1500 | 139 |
| GS HD - 28" P Tipi | 08542000N | Gizli Kanat | 23 | 16+0,5 | 707,5 | 10°/15°/20° | 2000 | 1500 | 155 |

RAGNİ 188 AD

Curtain Wall Handle
Cephe Kolu

Quantity/Miktar - Box/Kutu 20 PCS/Adet



RAGNİ 188 AD.1

Curtain Wall Handle
Cephe Kolu

Quantity/Miktar - Box/Kutu 20 PCS/Adet

GIESSE 5007

Curtain Wall Handle
Cephe Kolu

Quantity/Miktar - Box/Kutu 5 PCS/Adet

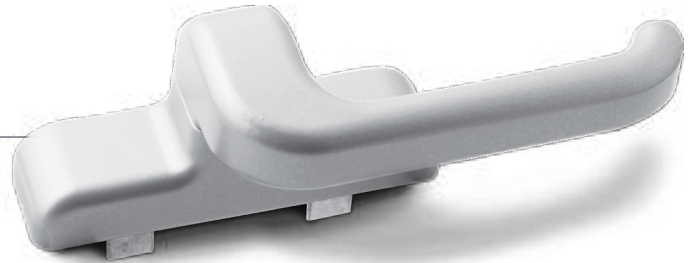

GIESSE 5008

Curtain Wall Handle With Key
Anahtarlı Cephe Kolu

Quantity/Miktar - Box/Kutu 5 PCS/Adet

• Curtain Wall Group | Cephe Grubu

AA 6001C

Curtain Wall Handle
Cephe Kolu

Quantity/Miktar - Box/Kutu 30 PCS/Adet

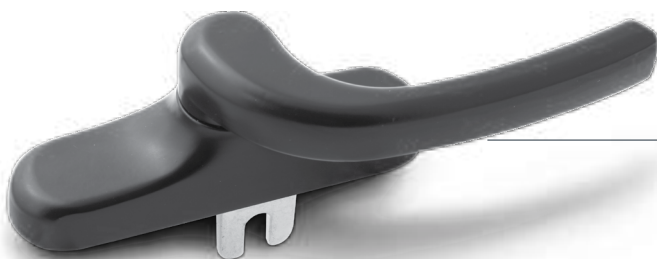
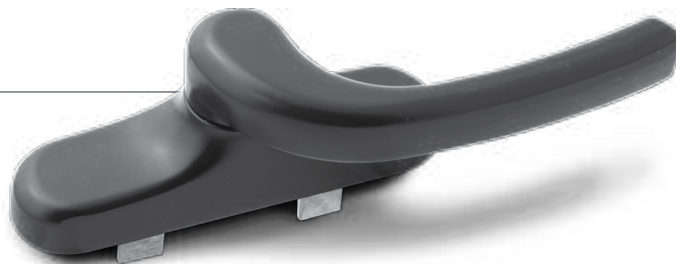

AA 6002C

Curtain Wall Handle
Cephe Kolu

Quantity/Miktar - Box/Kutu 30 PCS/Adet

288C

Curtain Wall Handle
Cephe Kolu

Quantity/Miktar - Box/Kutu 30 PCS/Adet



288T

Curtain Wall Handle
Cephe Kolu

Quantity/Miktar - Box/Kutu 30 PCS/Adet

RAGNİ 0083

Corner Transmission
Köşe Dönüşü

Quantity/Miktar - Box/Kutu 20 PCS/Adet



RAGNİ 0089

Curtain Wall Striker
Cephe Pim Karşılık

Quantity/Miktar - Box/Kutu 100 PCS/Adet

0289

Curtain Wall Striker
Cephe Pim Karşılık

Quantity/Miktar - Box/Kutu 100 PCS/Adet



0389

Curtain Wall Striker
Cephe Pim Karşılık

Quantity/Miktar - Box/Kutu 100 PCS/Adet

RAGNİ 0088

Connection Parts
Cephe Kol İletişim Ekipmanı

Quantity/Miktar - Box/Kutu 100 Kit/Takım



0153

Adjustable Pin
Ayarlı Pim

Quantity/Miktar - Box/Kutu 200 PCS/Adet

ANK-100

Aluminium Bracket
Alüminyum Ankraj

Size/Ölçü 55- 100

Quantity/Miktar - Box/Kutu 50 PCS/Adet



ANK-U

Galvanized Steel Bracket
Metal U Ankraj

Size/Ölçü A-55-080 B-55-100
C-55-120 D-55-150

Quantity/Miktar - Box/Kutu 20 PCS/Adet

ANK-H

Galvanized Steel Bracket
Metal H Ankraj

Size/Ölçü A-55-080 B-55-100
C-55-120 D-55-150

Quantity/Miktar - Box/Kutu 20 PCS/Adet



ANK-F

Galvanized Steel Bracket
Metal F Ankraj

Size/Ölçü A-55-080 B-55-100
C-55-120 D-55-150

Quantity/Miktar - Box/Kutu 20 PCS/Adet

ANK-L

Galvanized Steel Bracket
Metal L Ankraj

Size/Ölçü A-080 B-100
C-120 D-150

Quantity/Miktar - Box/Kutu 20 PCS/Adet

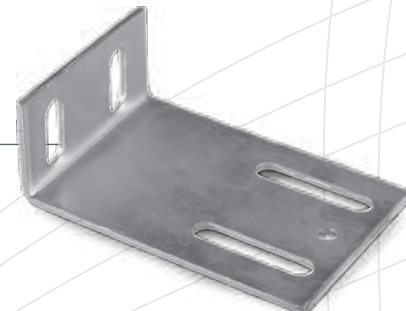

Sliding Accessories

Sürme Aksesuarları

● Sliding Accessories | Sürme Aksesuarları

EM38-32

Roller With Double Wheel
Çiftli Sürme Rulman

Quantity/Miktar - Box/Kutu 200 PCS/Adet



SR3382

Roller With Double Wheel
Çiftli Sürme Rulman

Quantity/Miktar - Box/Kutu 200 PCS/Adet

MS-0204

Roller With Double Wheel
Çiftli Sürme Rulman

Quantity/Miktar - Box/Kutu 200 PCS/Adet



MS-0101

Roller With Single Wheel
Tekli Sürme Rulman

Quantity/Miktar - Box/Kutu 200 PCS/Adet

EM-1602

Roller With Double Wheel
Çiftli Sürme Rulman

Quantity/Miktar - Box/Kutu 80 PCS/Adet



EM-1601

Roller With Single Wheel
Tekli Sürme Rulman

Quantity/Miktar - Box/Kutu 100 PCS/Adet

GIESSE 02911000

Roller With Double Wheel
Çiftli Sürme Rulman

Quantity/Miktar - Box/Kutu 100 PCS/Adet



GIESSE 02910000

Roller With Single Wheel
Tekli Sürme Rulman

Quantity/Miktar - Box/Kutu 100 PCS/Adet

MS-0201 (186)

Roller With Double Wheel
Çiftli Sürme Rulman

Quantity/Miktar - Box/Kutu 200 PCS/Adet



MS-0102 (188)

Roller With Single Wheel
Tekli Sürme Rulman

Quantity/Miktar - Box/Kutu 200 PCS/Adet

AK-309C

Roller With Double Wheel
Çiftli Sürme Rulman

Quantity/Miktar - Box/Kutu 50 PCS/Adet



• Sliding Accessories | Sürme Aksesuarları

AK-309T

Roller With Single Wheel
Tekli Sürme Rulman

Quantity/Miktar - Box/Kutu 100 PCS/Adet



AK-312C

Roller With Double Wheel
Çiftli Sürme Rulman

Quantity/Miktar - Box/Kutu 50 PCS/Adet

AK-312T

Roller With Single Wheel
Tekli Sürme Rulman

Quantity/Miktar - Box/Kutu 100 PCS/Adet



MS-20

Flyscreen Roller
Sineklik Rulman

Quantity/Miktar - Box/Kutu 100 PCS/Adet

EM-2013

Roller With Double Wheel
Çiftli Sürme Rulman

Quantity/Miktar - Box/Kutu 100 PCS/Adet

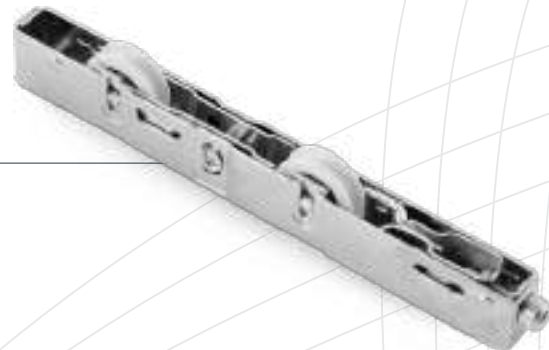

GIESSE 02983

Embedding Handle

Havuz Kol

Quantity/Miktar - Box/Kutu 20 PCS/Adet



GIESSE 02883

Embedding Handle Key

Anahtarlı Havuz Kol

Quantity/Miktar - Box/Kutu 20 PCS/Adet

GIESSE 05005000

Embedding Handle Striker

Havuz Kol Karşılık

Quantity/Miktar - Box/Kutu 20 PCS/Adet



GIESSE 02980

Sliding Handle

Sürme Kol

Quantity/Miktar - Box/Kutu 20 PCS/Adet

8105

Embedding Handle

Havuz Kol

Quantity/Miktar - Box/Kutu 100 PCS/Adet



8103T

Embedding Handle

Havuz Kol

Quantity/Miktar - Box/Kutu 100 PCS/Adet

• Sliding Accessories | Sürme Aksesuarları

RAGNI 312

Sliding Handle
Sürme Kol

Quantity/Miktar - Box/Kutu 20 PCS/Adet



RAGNI 312AD

Sliding Handle
Sürme Kol

Quantity/Miktar - Box/Kutu 20 PCS/Adet

RAGNI 312AS

Sliding Handle
Sürme Kol

Quantity/Miktar - Box/Kutu 20 PCS/Adet



RAGNI 312C

Sliding Handle Key
Anahtarlı Sürme Kol

Quantity/Miktar - Box/Kutu 20 PCS/Adet

RAGNI 0220

Recessed Sliding Handle
Gömme Sürme Kol

Quantity/Miktar - Box/Kutu 20 PCS/Adet



RB-751

Embedding Handle
Havuz Kol

Quantity/Miktar - Box/Kutu 20 PCS/Adet

X-820

Pull Handle
Çekme Kol

Quantity/Miktar - Box/Kutu 100 PCS/Adet

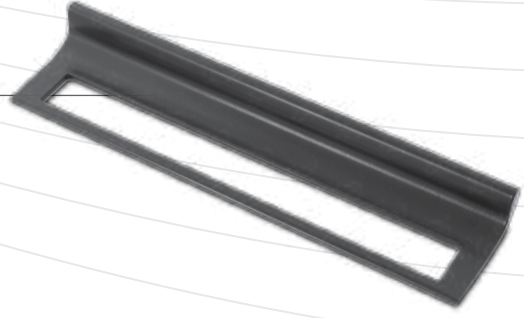

X-812

Pull Handle
Çekme Kol

Quantity/Miktar - Box/Kutu 100 PCS/Adet

301

Sliding Handle
Sürme Kol

Quantity/Miktar - Box/Kutu 40 PCS/Adet



302

Sliding Handle Key
Anahtarlı Sürme Kol

Quantity/Miktar - Box/Kutu 40 PCS/Adet

ART-102

Sliding Handle
Sürme Kol

Quantity/Miktar - Box/Kutu 40 PCS/Adet



ART-101

Sliding Handle
Sürme Kol

Quantity/Miktar - Box/Kutu 40 PCS/Adet

• Sliding Accessories | Sürme Aksesuarları

SMART

Sliding Handle Key
Anahtarlı Sürme Kol

Quantity/Miktar - Box/Kutu 50 PCS/Adet



8201

Sliding Handle
Sürme Kol

Quantity/Miktar - Box/Kutu 40 PCS/Adet

ART-103

Sliding Handle
Sürme Kol

Quantity/Miktar - Box/Kutu 20 PCS/Adet



AK-350

Sliding Handle
Sürme Kol

Quantity/Miktar - Box/Kutu 40 PCS/Adet

RAGNI 0201

Sliding Handle
Sürme Kol

Quantity/Miktar - Box/Kutu 20 PCS/Adet



MS-34

Plastic Corner Joint
Plastik Köşe

Width / Genişlik 19.40 Height / Yükseklik 17.70

Quantity/Miktar - Box/Kutu 100 PCS/Adet



MS-13

Plastic Corner Joint
Plastik Köşe

Width / Genişlik 19.40 Height / Yükseklik 13.10

Quantity/Miktar - Box/Kutu 100 PCS/Adet



MS-0330

Buffer
Stoper

Quantity/Miktar - Box/Kutu 100 PCS/Adet



MS-0320

Buffer
Stoper

Quantity/Miktar - Box/Kutu 100 PCS/Adet



MS-11

Buffer
Stoper

Quantity/Miktar - Box/Kutu 100 PCS/Adet



MS-10

Buffer
Stoper

Quantity/Miktar - Box/Kutu 100 PCS/Adet



MS-07

Central Seal
Hava Kesici

Quantity/Miktar - Box/Kutu 100 PCS/Adet



• Sliding Accessories | Sürme Aksesuarları

MS-0053

End Cover

Adaptör Kapağı

Quantity/Miktar - Box/Kutu 10 PCS/Adet



MS-903

End Cover

Adaptör Kapağı

Quantity/Miktar - Box/Kutu 100 PCS/Adet



EM38-23

Buffer

Stoper

Quantity/Miktar - Box/Kutu 100 PCS/Adet



MS-06

End Cover

Adaptör Kapağı

Quantity/Miktar - Box/Kutu 100 PCS/Adet



M0-97

End Cover

Adaptör Kapağı

Quantity/Miktar - Box/Kutu 100 PCS/Adet



M0-37

End Cover

Adaptör Kapağı

Quantity/Miktar - Box/Kutu 100 PCS/Adet



1247

End Cover

Adaptör Kapağı

Quantity/Miktar - Box/Kutu 100 PCS/Adet

GOS-S

Sürme ve Kaldır Sür

GIESSE 02913000

Lift & Slide Double Roller Kit
Kaldır Sür İkili Rulman Takımı

Quantity/Miktar - Box/Kutu 5 PCS/Adet



GIESSE 02916000

Lift & Slide Single Roller Kit
Kaldır Sür Tekli Rulman Takımı

Quantity/Miktar - Box/Kutu 5 PCS/Adet

GIESSE 02951000

Internal Device (For Handle)
Kare Milli Kol İletişim Ekipmanı

Quantity/Miktar - Box/Kutu 10 PCS/Adet



GIESSE 02952

Locking Mechanism
Kilitli Mekanizma

Quantity/Miktar - Box/Kutu 10 PCS/Adet

GIESSE 02908

Sliding Handle
Kare Milli Kol

Quantity/Miktar - Box/Kutu 5 PCS/Adet



GIESSE 02994

Sliding Handle
Tek Maçalı Sürme Kol

Quantity/Miktar - Box/Kutu 5 PCS/Adet



GIESSE 0291

Sliding Handle
Gömme Sürme Kol

Quantity/Miktar - Box/Kutu 5 PCS/Adet



GIESSE 02931000

Locking Kit
Dil ve Karşılık

Quantity/Miktar - Box/Kutu 50 PCS/Adet



GIESSE 02903000

Plastic Corner Joint
Plastik Köşe Gönye

Quantity/Miktar - Box/Kutu 100 PCS/Adet

GIESSE 02921000

Plastic Corner Joint
Plastik Köşe Gönye

Quantity/Miktar - Box/Kutu 100 PCS/Adet

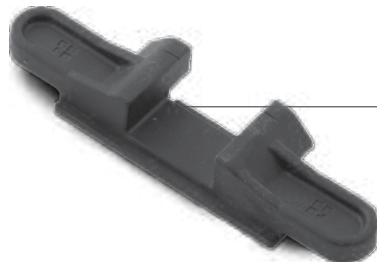

GIESSE 02940000

Sliding Handle Connection Part
Maçalı Kol İletişim Ekipmanı

Quantity/Miktar - Box/Kutu 100 PCS/Adet

• Sliding Accessories | Sürme Aksesuarları

GIESSE 02954000

Fixed Sash Kit

Sabit Kanat Mesafe Takozu

Quantity/Miktar - Box/Kutu 50 PCS/Adet



GIESSE 02939000

Lift & Slide Stoper

Kaldır Sür Stoper

Quantity/Miktar - Box/Kutu 50 PCS/Adet



GIESSE 02933000

Sliding Stoper

Sürme Stoper

Quantity/Miktar - Box/Kutu 50 PCS/Adet



GIESSE 02947000

4 Sash Adapter Cap

4 Kanat Adaptör Kapağı

Quantity/Miktar - Box/Kutu 10 PCS/Adet



GIESSE 02945000

Central Plugs Kit For Sliding

Sürme Kapak & Hava Kesici Takımı

Quantity/Miktar - Box/Kutu 50 PCS/Adet



GIESSE 02944000

Central Plugs Kit For L&S

Kaldır Sür Kapak & Hava Kesici Takımı

Quantity/Miktar - Box/Kutu 10 PCS/Adet

Locks

Kilitler

152-R

Mortise Lock With Cylinder

Silindirli Gömme Kilit

Size/Ölçü 152R-35 152R-40 152R-45

Quantity/Miktar - Box/Kutu 30 PCS/Adet



154

Mortise Lock With Cylinder

Silindirli Gömme Kilit

Size/Ölçü 154-35 154-40

Quantity/Miktar - Box/Kutu 30 PCS/Adet



153-U

Mortise Lock With Cylinder

Silindirli Gömme Kilit

Size/Ölçü 153U-20 153U-25

Quantity/Miktar - Box/Kutu 30 PCS/Adet



155-U

Mortise Lock With Cylinder

Silindirli Gömme Kilit

Size/Ölçü 155U-20 155U-25

Quantity/Miktar - Box/Kutu 30 PCS/Adet



153

Mortise Lock With Cylinder
Silindirli Gömme Kilit Gövde

Size/Ölçü 153-20 153-25 153-30 153-35

Quantity/Miktar - Box/Kutu 30 PCS/Adet



155

Mortise Lock With Cylinder
Silindirli Gömme Kilit Gövde

Size/Ölçü 155-20 155-25 155-30 155-35

Quantity/Miktar - Box/Kutu 30 PCS/Adet



153-P

Mortise Lock With Cylinder
Silindirli Gömme Kilit Gövde

Size/Ölçü 153-20 153-25 153-30 153-35

Quantity/Miktar - Box/Kutu 30 PCS/Adet



155-P

Mortise Lock With Cylinder
Silindirli Gömme Kilit Gövde

Size/Ölçü 155-20 155-25 155-30 155-35

Quantity/Miktar - Box/Kutu 30 PCS/Adet

269-WC

Interior Mortise Lock

İç Kapı Gömme Kilit

Size/Ölçü 269-20 269-25 269-30 269-35

Quantity/Miktar - Box/Kutu 30 PCS/Adet



269-PWC

Interior Mortise Lock

İç Kapı Gömme Kilit

Size/Ölçü 269-20 269-25 269-30 269-35

Quantity/Miktar - Box/Kutu 30 PCS/Adet

164-GNC

Cylinder

Silindir

Size/Ölçü A-62mm B-68mm C-76mm D-90mm

Quantity/Miktar - Box/Kutu 24 PCS/Adet



164GC

Cylinder

Silindir

Size/Ölçü A-68mm B-76mm C-90mm

Quantity/Miktar - Box/Kutu 24 PCS/Adet

BR-001

Cylinder

Silindir

Size/Ölçü A/26+10+40=76 B/26+10+45=81
C/26+10+54=90 D/26+10+65=101

Quantity/Miktar - Box/Kutu 30 PCS/Adet



KD002/50-440

Door Closer / Standart
Kapı Hidroliği / Standart

Size/Ölçü 1050mm x 2400mm

Door Weight/Kapı Ağırlığı 60-85 kg

Quantity/Miktar - Box/Kutu 10 PCS/Adet



KD002/50-550

Door Closer / Standart
Kapı Hidroliği / Standart

Size/Ölçü 1200mm x 2400mm

Door Weight/Kapı Ağırlığı 80-120 kg

Quantity/Miktar - Box/Kutu 10 PCS/Adet

KD002/50-330

Door Closer / Standart
Kapı Hidroliği / Standart

Size/Ölçü 950mm x 2100mm

Door Weight/Kapı Ağırlığı 40-65 kg

Quantity/Miktar - Box/Kutu 10 PCS/Adet



KD002/40-330

Door Closer / Sliding Arm
Kapı Hidroliği / Raylı

Size/Ölçü 1000mm

Door Weight/Kapı Ağırlığı 65 kg

Quantity/Miktar - Box/Kutu 10 PCS/Adet

•Door Cloeser | Kapı Hidroliđi

KD002/40-440

Door Closer / Sliding Arm
Kapı Hidroliđi / Raylı

Size/Ölçü 1100mm

Door Weight/Kapı Ađırlıđı 90 kg

Quantity/Miktar - Box/Kutu 10 PCS/Adet



KD002/50-400

Door Closer / Power Adjustable
Kapı Hidroliđi / Güç Ayarlı

Size/Ölçü 1200mm x 2400mm

Door Weight/Kapı Ađırlıđı 25-120 kg

Quantity/Miktar - Box/Kutu 10 PCS/Adet

KD040/30-250

Panic Device
Panik Bar

Quantity/Miktar - Box/Kutu 10 PCS/Adet



KD040/30-291

Panic Device / Outer Arm
Panik Bar / Dış Kol

Quantity/Miktar - Box/Kutu 10 PCS/Adet

Hand Tools

El Aletleri

KH-3001

Triple Plastic Cupping
Üçlü Plastik Vantuz



KH-3002

Triple Metal Cupping
Üçlü Metal Vantuz

KH-3004

Double Plastic Cupping
İkili Plastik Vantuz



KH-3005

Double Metal Cupping
İkili Metal Vantuz

KH-3014

Diamond Glass Cutter
Gazlı Cam Elması



KH-3015

Diamond Glass Cutter
Gazlı Cam Elması

KH-3022

Spare Cutter
Yedek Kesici



KH-3024

Spare Wheel
Yedek Teker

KH-3025

T Cutter
T Keser
Size/Ölçü A/150 B/180 C/200

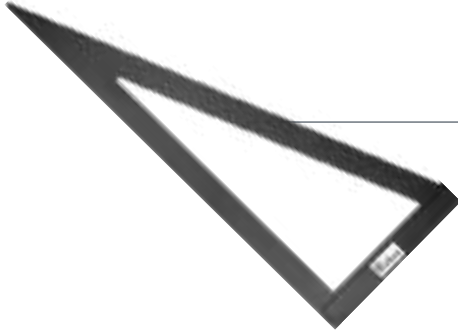

KH-3034

Miter
Gönye

KH-3038

Circle Glass Cutter
Daire Kesen Elmas



KH-3041

Glass Plier
Cam Kirma Pensesi

• Hand Tools | El Aletleri

KH-3085

Marble Piercing
Mermer Delici



KH-3087

Inox Cutter
İnoks Kesici
Size/Ölçü: A/115 B/180



KH-3097

Shutter Rope
Panjur Kordonu



KH-3053

Gloves
Eldiven

KH-3055

Tape Measure
Metre
Size/Ölçü A/3Mt. B/5Mt.



KH-3056

Tape Measure
Metre
Size/Ölçü A/3Mt. B/5Mt.

KH-3068

Foam Pistol
Köpük Tabancası

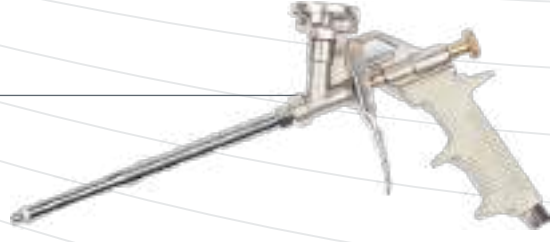

KH-3064

Air Pistol
Hava Tabancası

KH-3025

Air Pistol
Hava Tabancası



KH-3058

Epoxy Pistol
Epoksi Tabancası

KH-3060

Silicon Pistol
Silikon Tabancası



KH-3061

Silicon Pistol
Silikon Tabancası

• Hand Tools | El Aletleri

KH-3071

Sketch Knife
Maket Bıçağı



KH-3072

Spare Knife
Yedek Bıçak

KH-3074

Plastic Hammer
Plastik Çekiç
Size/ölçü A/30 B/40 C/50



KH-3075

Plastic Hammer
Plastik Çekiç
Size/ölçü A/35 B/45

KH-3077

Glass Lighting Shovel
Cam Kaldırma Küreği



KH-3073

Glass Scraper
Cam Kazıyıcı

KH-3082

Router Bits
Freze Ucu

Size/ölçü A/5x6x60 B/5x8x60 C/5x8x80 D/5x8x100 E/5x8x120



KH-3078

Screwdriver Bits
Yıldız Uç

Size/ölçü A/50 B/75 C/100 D/150



KH-3079

Torx Bits
Torks Uç

Size/ölçü A/50 B/75 C/100 D/150



KH-3080

Metal Drill
Matkap Ucu

Size/ölçü 2.5mm / 3.0mm / 4.0mm / 4.2mm
4.5mm / 5.0mm / 6.0mm / 7.00mm / 8mm



KH-3081

Concrete Drill
Beton Delici

Size/ölçü 6x160-210-260 / 7x160x210x260 / 8x160x210x260



KH-4100

Tool Box
Takım Çantası

Size/ölçü A-19 B-22 B-24

• Hand Tools | El Aletleri

KH-4150

Allen Keys
Alyan Anahtarı

Size/Ölçü A-2mm B-2,5mm C-3mm
D-4mm E-5mm F-6mm

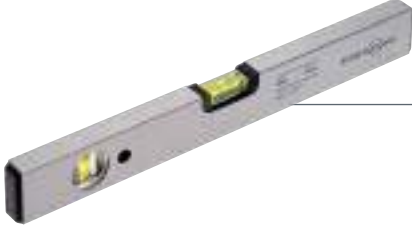

KH-4300

Aluminium Level
Alüminyum Su Terazisi

Size/Ölçü A-60cm B-80cm C-100cm

KH-4600

Extension Cable
Ara Kablo

Size/Ölçü A-35mt B-50mt

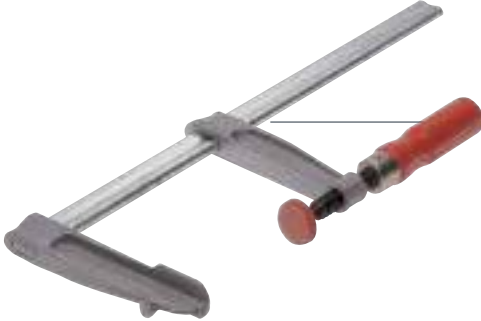

KH-4750

Clamp
Mengene

Size/Ölçü A-60cm B-80cm C-100cm
D-120cm E-150cm F-200cm

KH-4900

Hacksaw
Demir Testere Kolu

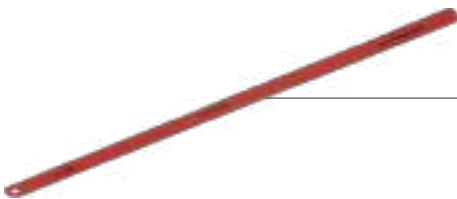
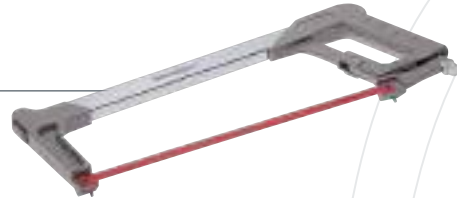

KH-4901

Metal Cutter
Demir Testere Ağzı

PILANA-A

Disc Saw
Elmas Testere

Size/Ölçü ø200-64 ø250-80 ø300-96
ø350-108 ø400-120 ø420-120



PILANA-D

Disc Saw
Derz Açma Testere

Size/Ölçü ø180-18 ø200-18



PILANA-K

Disc Saw
Ağırtma Bıçağı



PK 35F

Section and Pipe Bending Machine
Profil ve Boru Kıvrırma Makinası



HPK 50

Profile And Section Bending Machine
Profil ve Boru Kıvrırma Makinası

ALFA

Portable Cutting Machine Ø 300 mm
Portatif Kesim Makinesi Ø 300 mm



BETA

Portable Cutting Machine with Tilting Head Ø 300 mm
Portatif Yatarlı Kesim Makinesi Ø 300 mm



POLAR I

Portable End Milling Machine
Portatif Orta Kayıt Alıştırma Makinesi



STAR

Portable Copy Router Machine
Portatif Kopya Freze Makinesi

KD-305

Portable Cutting Machine Ø 300 mm
Portatif Kesim Makinesi Ø 300 mm

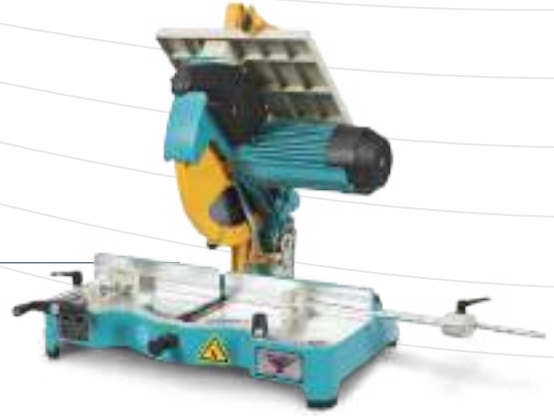

KY-305

Portable Cutting Machine with Tilting Head Ø 300 mm
Portatif Yatarlı Kesim Makinesi Ø 300 mm



KM-212

Portable End Milling Machine
Portatif Orta Kayıt Alıştırma Makinesi



FR-222

Portable Copy Router Machine
Portatif Kopya Freze Makinesi

• Machine Group | Makina Grubu

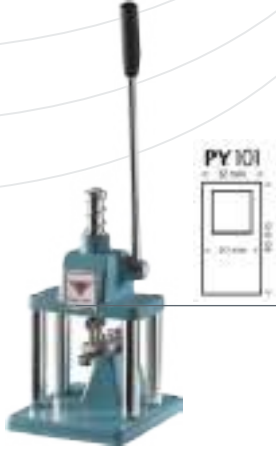

PY-100

Punch Press
Panç Pres



PY-101

Punch Press
Panç Pres



PY-102

Punch Press
Panç Pres



PY-104

Punch Press
Panç Pres



IMAX-P

Punch Press
Panç Pres



IMAX-M

Punch Press
Panç Pres



OPT 4080-6 (R+L)

Screwdriver
Havalı Tornavida



OPT 4080-8 (R+L)

Screwdriver
Havalı Tornavida



OPT 232 (R+L)

Drill
Havalı Matkap



OPT 120

Air Die Grinder
Havalı Taşlama



OPT 124

Air Die Grinder
Havalı Taşlama



OPT 103R

Air Rivet Pistol
Havalı Perçin Tabancası



OPT 3042

Air Control Unit
Şartlandırıcı



OPT 3012

Air Control Unit
Şartlandırıcı

• Pneumatic Hand Tools | Havalı El Aletleri



OPT 2042

Air Control Unit
Şartlandırıcı



OPT 203

Air Silicon Pistol
Havalı Silikon Tabancası



LBP 01

Spiral Polyurethane Air Hose
Hava Hortumu

Size/Ölçü 7,5mt - 15mt



DWS 38ES

2'li Gövde



VWS 38ES

3'lü Gövde



ES 38A

Stoper Erkek



ES 38I

Stoper Dişi



ES 14NA

Rekor Uç Erkek



ES 14NI

Rekor Uç Dişi

Glass Materials

Cam Malzemeler

• Glass Materials | Cam Malzemeleri

SEL-001

Multi Purpose Silicone
Genel Amaçlı Silikon

Weight/Ağırlık 310ml / 280ml

Color/Renk
White, transparent, black, grey, brown, beige
Beyaz, şeffaf, siyah, gri, kahverengi, bej



SEL-002

Neutral Silicone
Nötr Silikon

Weight/Ağırlık 310ml

Color/Renk
Black, grey, white, brown, transparent
Siyah, gri, beyaz, kahverengi, şeffaf

SEL-003

Sausage Silicone
Sosis Silikon

Weight/Ağırlık 400ml / 600ml

Color/Renk
White, transparent, black
Beyaz, şeffaf, siyah



SEL-004

Foam
Köpük

Weight/Ağırlık 750ml / 500ml

SEL-005

Gun P-U Foam
Tabanlı Köpük

Weight/Ağırlık 750ml / 500ml



SEL-006

Foam Cleaner Spray
Köpük Temizleyici Sprey



SEL-007

Marble Adhesive
Mermer Yapıştırıcı

Weight/Ağırlık 1000gr

SEL-008

Epoxy Based
Kimyasal Dübel

Weight/Ağırlık 345ml



GN-101

Hotmelt
Çift Cam Macunu

Weight/Ağırlık 6.5 kg

GN-102

Thicol A+B
Çift Cam Macunu

Weight/Ağırlık 30+3 kg



• Glass Materials | Cam Malzemeleri

GN-105

Glazing Sash
Isıcam Çıtası

Size/Ölçü 6 - 9 - 10.5 - 12 - 14.5 - 15.5 - 19.5 mm



GN-106

Clips
Klips

Size/Ölçü 6 - 9 - 10.5 - 12 - 14.5 - 15.5 - 19.5 mm

GN-107

Silicogel
Nem Alıcı

Weight/Ağırlık 25 kg

